

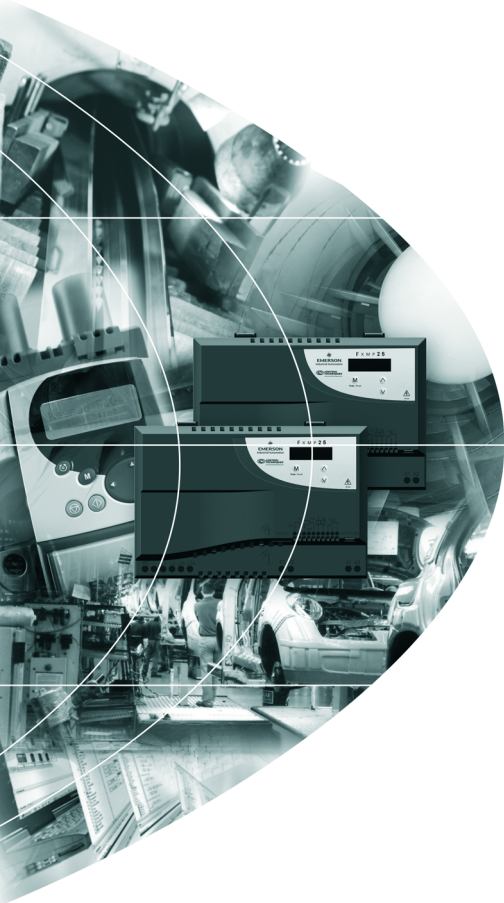

EMERSON[™]
Industrial Automation



User Guide

FXMP25

Field Controller

Part Number: 0476-0009-03
Issue: 3



www.controltechniques.com

General Information

The manufacturer accepts no liability for any consequences resulting from inappropriate, negligent or incorrect installation or adjustment of the optional operating parameters of the equipment or from mismatching the field controller with the motor.

The contents of this guide are believed to be correct at the time of printing. In the interests of a commitment to a policy of continuous development and improvement, the manufacturer reserves the right to change the specification of the product or its performance, or the contents of the guide, without notice.

All rights reserved. No parts of this guide may be reproduced or transmitted in any form or by any means, electrical or mechanical including photocopying, recording or by an information storage or retrieval system, without permission in writing from the publisher.

Field Controller software version

This product is supplied with the latest software version. If this drive is to be connected to an existing system or machine, all drive software versions should be verified to confirm the same functionality as drives of the same model already present. This may also apply to drives returned from a Control Techniques Service Centre or Repair Centre. If there is any doubt please contact the supplier of the product. The software versions of the drive can be checked by looking at Pr **97** and Pr **99**.

When used in conjunction with a Mentor MP the Mentor MP software must be V01.05.01 or later.

Environmental statement

Control Techniques is committed to minimising the environmental impacts of its manufacturing operations and of its products throughout their life cycle. To this end, we operate an Environmental Management System (EMS) which is certified to the International Standard ISO 14001. Further information on the EMS, our Environmental Policy and other relevant information is available on request, or can be found at www.greendrives.com.

The electronic variable-speed drives manufactured by Control Techniques have the potential to save energy and (through increased machine/process efficiency) reduce raw material consumption and scrap throughout their long working lifetime. In typical applications, these positive environmental effects far outweigh the negative impacts of product manufacture and end-of-life disposal.

Nevertheless, when the products eventually reach the end of their useful life, they must not be discarded but should instead be recycled by a specialist recycler of electronic equipment. Recyclers will find the products easy to dismantle into their major component parts for efficient recycling. Many parts snap together and can be separated without the use of tools, while other parts are secured with conventional fasteners. Virtually all parts of the product are suitable for recycling.

Product packaging is of good quality and can be re-used. Large products are packed in wooden crates, while smaller products come in strong cardboard cartons which themselves have a high recycled fibre content. If not re-used, these containers can be recycled. Polythene, used on the protective film and bags for wrapping product, can be recycled in the same way. Control Techniques' packaging strategy prefers easily-recyclable materials of low environmental impact, and regular reviews identify opportunities for improvement.

When preparing to recycle or dispose of any product or packaging, please observe local legislation and best practice.

REACH legislation

EC Regulation 1907/2006 on the Registration, Evaluation, Authorisation and restriction of Chemicals (REACH) requires the supplier of an article to inform the recipient if it contains more than a specified proportion of any substance which is considered by the European Chemicals Agency (ECHA) to be a Substance of Very High Concern (SVHC) and is therefore listed by them as a candidate for compulsory authorisation.

For current information on how this requirement applies in relation to specific Control Techniques products, please approach your usual contact in the first instance. Control Techniques position statement can be viewed at:

<http://www.controltechniques.com/REACH>

Copyright © October 2011 Control Techniques Ltd.

Issue Number: 3

Contents

1	Safety information	6
1.1	Warnings, cautions and notes	6
1.2	Electrical safety - general warning	6
1.3	System design and safety of personnel	6
1.4	Environmental limits	7
1.5	Access	7
1.6	Fire protection	7
1.7	Compliance with regulations	7
1.8	Motor	7
1.9	Adjusting parameters	7
1.10	Electrical installation	8
2	Product information	9
2.1	Ratings	9
2.2	Nameplate description	9
2.3	FXMP25 features and options	10
3	Mechanical installation	11
3.1	Fire protection	11
3.2	Electrical terminals	14
3.3	Routine maintenance	14
4	Electrical installation	15
4.1	Electrical connections	16
4.2	Protective ground connections	17
4.3	AC supply requirements	17
4.4	Line reactors	17
4.5	Cable and fuse size ratings	18
5	Getting started	27
5.1	Keypad and display	27
5.2	Resetting the field controller	28
5.3	Security	28
5.4	Setting the controller back to default values	29
5.5	Saving parameters	29
6	Parameters	30
6.1	Full parameter descriptions	31

7	Setting-up	44
8	Technical data	53
8.1	Ratings	53
8.2	FXMP25 derating for extended ambient operation	53
8.3	Power dissipation	53
8.4	AC supply requirements	54
8.5	Line reactors	54
8.6	Temperature and humidity	55
8.7	Storage	55
8.8	Altitude	55
8.9	IP rating	55
8.10	Corrosive gasses	56
8.11	RoHS compliance	56
8.12	Vibration	56
8.13	Acoustic noise	57
8.14	Overall dimensions	57
8.15	Weight	57
8.16	Cable and fuse size ratings	57
8.17	Electromagnetic compatibility (EMC)	58
9	Diagnostics	60
10	UL listing information	64
10.1	Conditions of acceptability	64
10.2	AC supply specification	64
10.3	Maximum continuous current	64

Declaration of Conformity

Control Techniques Ltd, The Gro, Newtown, Powys UK. SY16 3BE

FXMP25 Field Controller

The field controller product listed above has been designed and manufactured in accordance with the following European harmonized standards:

EN 61800-5-1:2007	Adjustable speed electrical power drive systems - safety requirements - electrical, thermal and energy
EN 61800-3:2004	Adjustable speed electrical power drive systems. EMC product standard including specific test methods
EN 61000-6-2:2005	Electromagnetic compatibility (EMC). Generic standards. Immunity standard for industrial environments
EN 61000-6-4:2007	Electromagnetic compatibility (EMC). Generic standards. Emission standard for industrial environments

The corresponding international standards are:

IEC 61800-5-1:2007

IEC 61800-3:2004

IEC 61000-6-2:2005

IEC 61000-6-4:2006

These products comply with the Low Voltage Directive 2006/95/EC and the Electromagnetic Compatibility (EMC) Directive 2004/108/EC.



T. Alexander
VP Technology
Newtown
Date: 8th July 2010

This electronic field controller product is intended to be used with appropriate motors, controllers, electrical protection components and other equipment to form complete end products or systems. Compliance with safety and EMC regulations depends upon installing and configuring drives correctly, including using the specified input filters. The drives must be installed only by professional assemblers who are familiar with requirements for safety and EMC. The assembler is responsible for ensuring that the end product or system complies with all the relevant laws in the country where it is to be used. Refer to the User Guide. An EMC Data Sheet is also available giving detailed EMC information.

1 Safety information

1.1 Warnings, cautions and notes



A **Warning** contains information, which is essential for avoiding a safety hazard.



A **Caution** contains information, which is necessary for avoiding a risk of damage to the product or other equipment.

NOTE A **Note** contains information which helps to ensure correct operation of the product.

1.2 Electrical safety - general warning

The voltages used in the field controller can cause severe electrical shock and/or burns, and could be lethal. Extreme care is necessary at all times when working with or adjacent to the field controller.

Specific warnings are given at the relevant places in this Guide.

1.3 System design and safety of personnel

The field controller is intended as a component for professional incorporation into complete equipment or system. If installed incorrectly, the field controller may present a safety hazard.

The field controller uses high voltages and currents, carries a high level of stored electrical energy, and is used to control equipment which can cause injury.

System design, installation, commissioning / start-up and maintenance must be carried out by personnel who have the necessary training and experience. They must read this safety information and this guide carefully.

The electrical inputs of the field controller must not be relied upon to ensure safety of personnel. They do not isolate dangerous voltages from the output of the field controller. The supply must be disconnected by an approved electrical isolation device before gaining access to the electrical connections.

The field controller is not intended to be used for safety-related functions.

Careful consideration must be given to the function of the field controller which might result in a hazard, either through its intended behavior or through incorrect operation due to a fault. In any application where a malfunction of the field controller or its control system could lead to or allow damage, loss or injury, a risk analysis must be carried out, and where necessary, further measures taken to reduce the risk - for example, an over-speed protection device in case of failure of the field control.

1.4 Environmental limits

Instructions within the supplied data regarding transport, storage, installation and the use of the field controller must be complied with, including the specified environmental limits. Field controllers must not be subjected to excessive physical force.

1.5 Access

Access must be restricted to authorized personnel only. Safety regulations which apply at the place of use must be complied with.

1.6 Fire protection

The field controller enclosure is not classified as a fire enclosure. A separate fire enclosure must be provided. For further information refer to section 3.1 *Fire protection* on page 11.

1.7 Compliance with regulations

The installer is responsible for complying with all relevant regulations, such as national wiring regulations, accident prevention regulations and electromagnetic compatibility (EMC) regulations. Particular attention must be given to the cross-sectional areas of conductors, the selection of fuses and other protection, and protective ground connections.

The *FXMP25 User Guide* contains instructions for achieving compliance with specific EMC standards.

Within the European Union, all machinery in which this product is used must comply with the following directives:

2006/42/EC: Safety of machinery

2004/108/EC: Electromagnetic compatibility

1.8 Motor

Ensure the motor is installed in accordance with the manufacturer's recommendations. Ensure the motor shaft is not exposed.

Low speeds may cause the motor to overheat because the cooling fan becomes less effective. The motor should be installed with a protection thermistor. If necessary, an electric forced ventilation fan should be used.

The values of the motor parameters set in the field controller affect the protection of the motor. The default values in the field controller should not be relied upon.

1.9 Adjusting parameters

Some parameters have a profound effect on the operation of the field controller. They must not be altered without careful consideration of the impact on the controlled system. Measures must be taken to prevent unwanted changes due to error or tampering.

1.10 Electrical installation

1.10.1 Electric shock risk

The voltages present in the following locations can cause severe electric shock and may be lethal:

- AC supply cables and connections
- Output cables and connections
- Many internal parts of the field controller

Unless otherwise indicated, control terminals are single insulated and must not be touched.

1.10.2 Stored charge

The field controller contains capacitors that remain charged to a potentially lethal voltage after the AC supply has been disconnected. If the field controller has been energized, the AC supply must be isolated at least five minutes before work may continue.

2 Product information

2.1 Ratings

Maximum continuous input current

The value of the maximum continuous input current is given to aid the selection of cables and fuses. The value is stated for worst-case conditions.

Continuous AC input current A	Continuous DC output current A
26	25

2.2 Nameplate description

Figure 2-1 Typical FXMP25 rating label

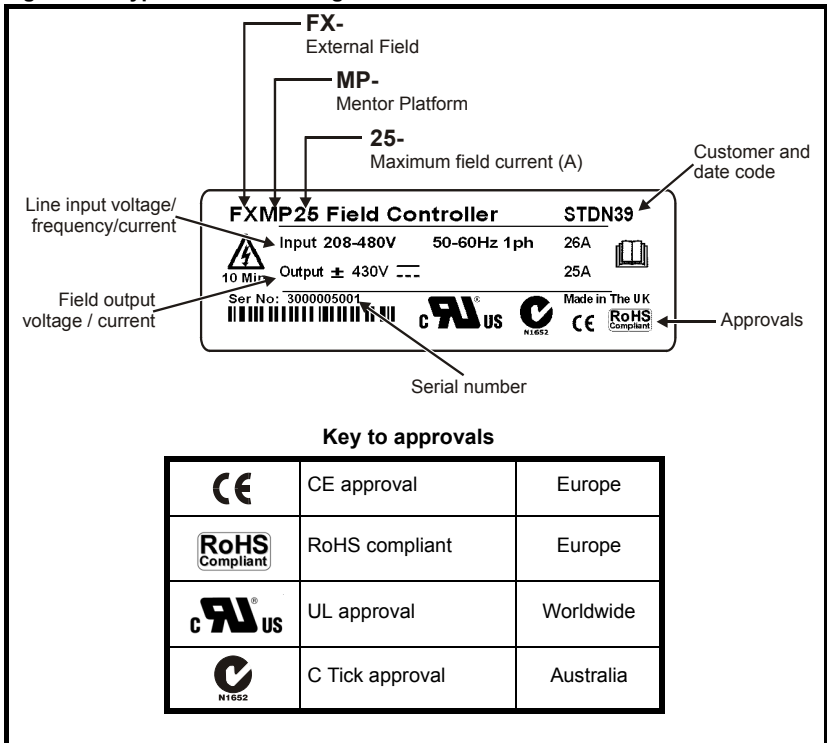

2.2.1 Output current

The continuous output current ratings given on the rating label are for maximum 40°C (104 °F) and 1000 m altitude. Derating is required for higher ambient temperatures >40 °C (104 °F) and higher altitude. For derating information, refer to Chapter 8 *Technical data* on page 53.

2.2.2 Input current

The input current given on the rating label is the typical input current.

2.3 FXMP25 features and options

Figure 2-2 FXMP25 features

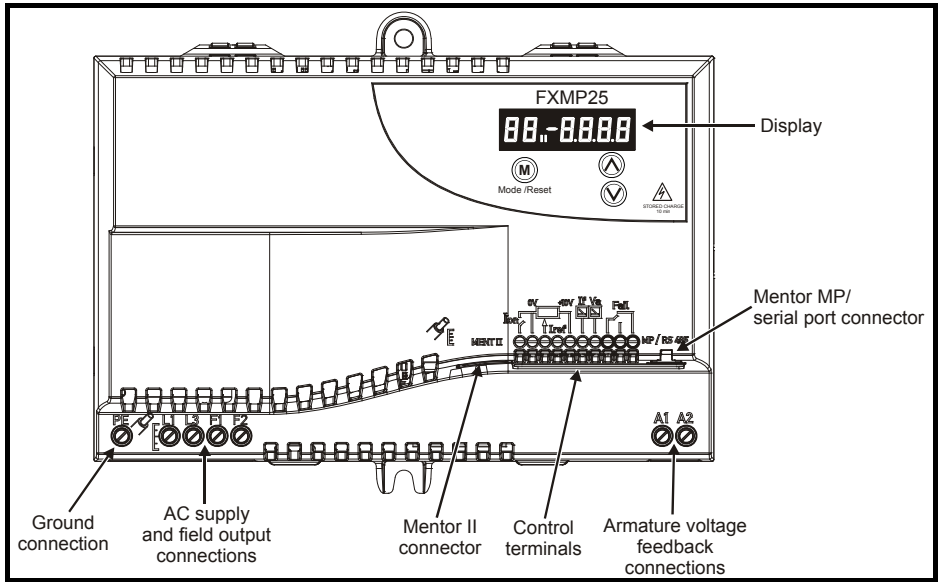

2.3.1 Options available for FXMP25

Table 2-1 Options

Type	Cable	Name	Further Details
Serial comms lead		CT Comms cable	CT EIA (RS) -232 (4500-0087) CT USB (4500-0096)

See also section 4.8 *Serial communications* on page 25 for information regarding serial communications.

3 Mechanical installation

 Follow the instructions

The mechanical and electrical installation instructions must be adhered to. Any questions or doubt should be referred to the supplier of the equipment. It is the responsibility of the owner or user to ensure that the installation of the field controller, and the way in which it is operated and maintained, comply with the requirements of the Health and Safety at Work Act in the United Kingdom or applicable legislation and regulations and codes of practice in the country in which the equipment is used.

 Competence of the installer

The field controller must be installed by professional assemblers who are familiar with the requirements for safety and EMC. The assembler is responsible for ensuring that the end product or system complies with all the relevant laws in the country where it is to be used.

 Enclosure

The field controller is intended to be mounted in an enclosure which prevents access except by trained and authorized personnel, and which prevents the ingress of contamination. It is designed for use in an environment classified as pollution degree 2 in accordance with IEC 60664-1. This means that only dry, non-conducting contamination is acceptable.

 The equipment enclosure is rated at IP20 in accordance with IEC60529. It is designed for installation within a protective enclosure which prevents unauthorized access except for trained service personnel, and prevents contamination with conductive dust and condensation.

 The field controller enclosure is not classified as a fire enclosure. A separate fire enclosure must be provided. For further information refer to section 3.1 below.

3.1 Fire protection

The field controller enclosure is not classified as a fire enclosure. A separate fire enclosure must be provided.

For installation in the USA, a NEMA 12 enclosure is suitable.

For installation outside the USA, the following (based on IEC 62109-1, standard for PV inverters) is recommended.

Enclosure can be metal and/or polymeric, polymer must meet requirements which can be summarized for larger enclosures as using materials meeting at least UL 94 class 5VB at the point of minimum thickness.

Air filter assemblies to be at least class V-2.

The location and size of the bottom shall cover the area shown in Figure 3-1. Any part of the side which is within the area traced out by the 5 ° angle is also considered to be part of the bottom of the fire enclosure.

Figure 3-1 Fire enclosure bottom layout

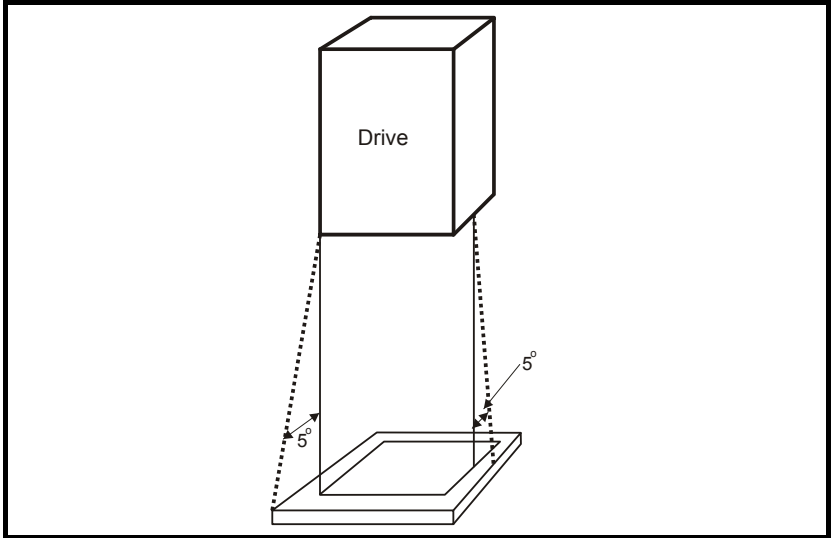

The bottom, including the part of the side considered to be part of the bottom, must be designed to prevent escape of burning material - either by having no openings or by having a baffle construction. This means that openings for cables etc. must be sealed with materials meeting the 5VB requirement, or else have a baffle above.

See Figure 3-2 for acceptable baffle construction. This does not apply for mounting in an enclosed electrical operating area (restricted access) with concrete floor.

Figure 3-2 Fire enclosure baffle construction

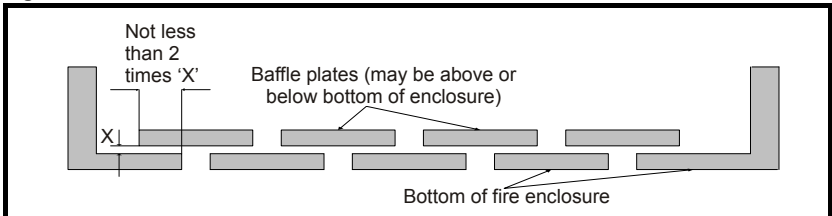

Figure 3-3 Overall dimensions

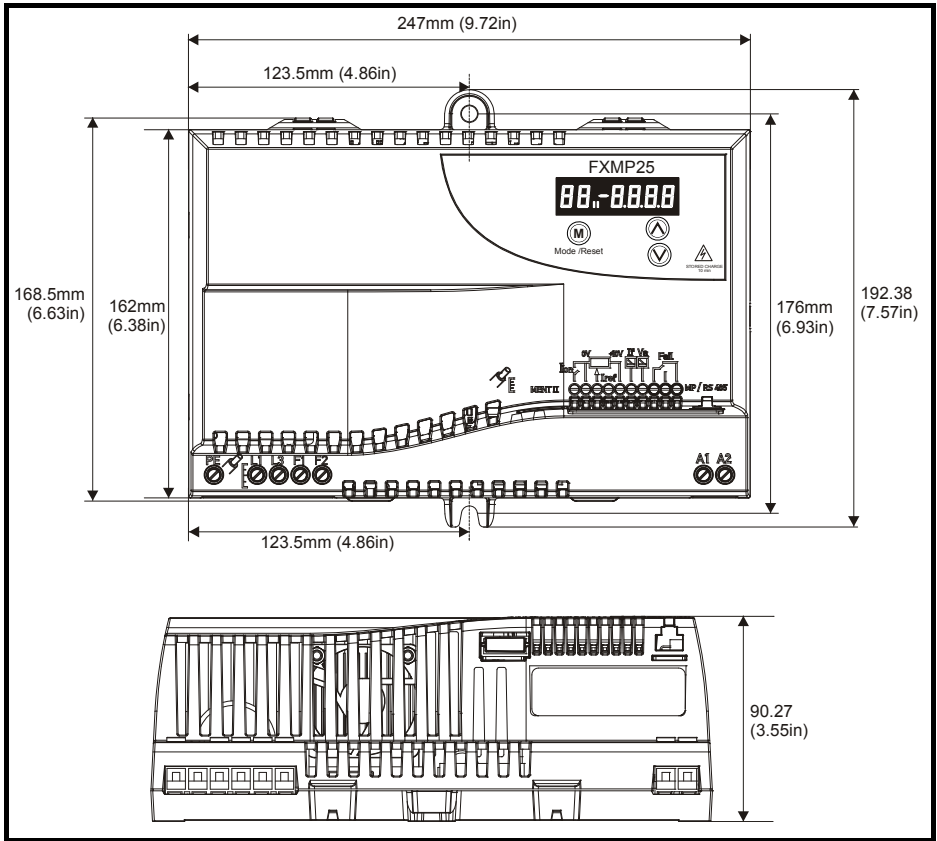

Table 3-1 Back-plate information

Recommended screw size	Torque range
M6	1.5 N m (1.1 lb ft) to 2.5 N m (1.8 lb ft)

Safety information

Product information

Mechanical installation

Electrical installation

Getting started

Parameters

Setting-up

Technical data

Diagnostics

UL listing information

3.2 Electrical terminals

Figure 3-4 Location, terminal size and torque setting of power and protective ground terminals

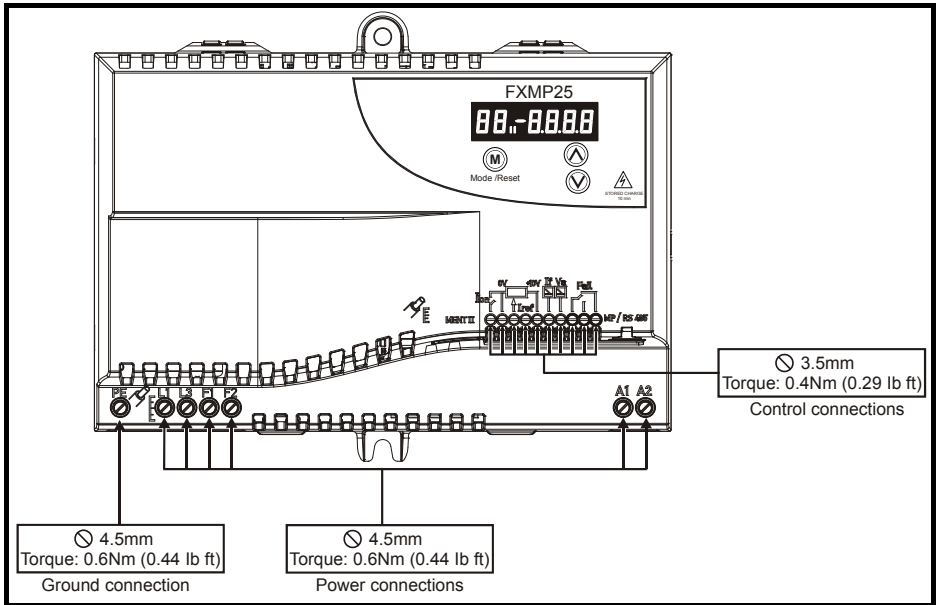

3.3 Routine maintenance

The FXMP25 should be installed in a cool, clean, well ventilated location. Contact with moisture and dust should be prevented.

Regular checks of the following should be carried out to ensure the installation reliability is maximized:

Environment	
Ambient temperature	Ensure the enclosure temperature remains at or below maximum specified
Dust	Ensure the FXMP25 remains dust free
Moisture	Ensure the FXMP25 enclosure shows no signs of condensation
Enclosure	
Enclosure door filters	Ensure filters are not blocked and that air is free to flow
Electrical	
Screw connections	Ensure all screw terminals remain tight
Crimp terminals	Ensure all crimp terminals remains tight – check for any discoloration which could indicate overheating
Cables	Check all cables for signs of damage

4 Electrical installation



Electric shock risk

The voltages present in the following locations can cause severe electric shock and may be lethal:

- AC supply cables and connections.
- DC cables, and connections.
- Many internal parts of the field controller.
- Control terminals are single insulated and must not be touched.



The voltages present in the FXMP25 controller are capable of inflicting a severe electric shock and may be lethal. The Stop function of the Drive does not remove dangerous voltages from the FXMP25 controller or the driven machine.

AC supplies to the FXMP25 controller must be disconnected at least 5 minutes before any cover is removed or servicing work is performed.



Isolation device

The AC supply must be disconnected from the field controller using an approved isolation device before any cover is removed from the field controller or before any servicing work is performed.



The field controller is suitable for use on supplies of installation category III and lower, according to IEC 60664-1. This means they may be connected permanently to the supply at its origin in a building, but for outdoor installation additional over-voltage suppression (transient voltage surge suppression) must be provided to reduce category IV to category III.



ELV circuits are single insulated (basic insulation) only. Installer required to provide supplementary insulation of accessible parts.

4.1 Electrical connections

When operating in stand alone mode, a relay should be provided to indicate to the controller that the unit has tripped and to protect against an overspeed condition.

Figure 4-1 FXMP25 power connections

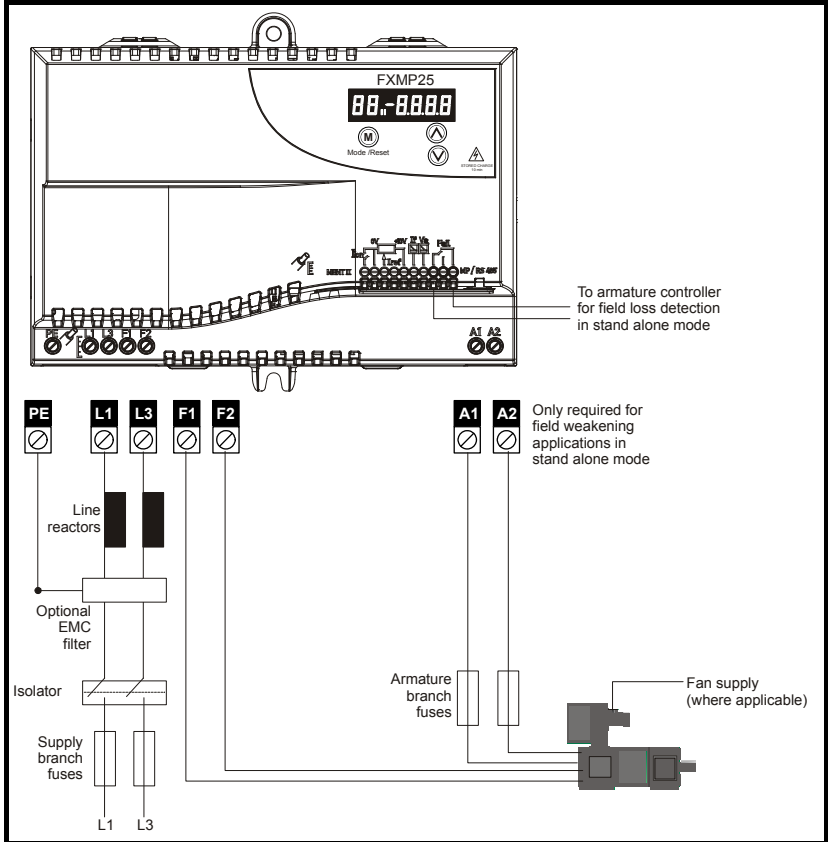

NOTE

If the voltage rating of the field is much lower than the supply voltage it is advisable to use a transformer to reduce the supply voltage. This maximises the resolution of the controller and prevents the possibility of excessive voltage being applied to the field winding.

4.2 Protective ground connections

The field controller must be connected to the system protective ground of the AC supply. The protective ground wiring must conform to local regulations and codes of practice. See section 4.3.1 *MOV protective ground disconnect* on page 17 for possible exceptions.



Ground loop impedance

The ground loop impedance must conform to the requirements of local safety regulations.

The field controller must be connected by a protective ground connection capable of carrying the prospective fault current until the protective device (fuse etc.) disconnects the AC supply. The protective ground connections must be inspected and tested at appropriate intervals.

4.3 AC supply requirements

For detailed information regarding AC supply requirements, please refer to section 8.4 *AC supply requirements* on page 54.

4.3.1 MOV protective ground disconnect

In some special circumstances, for example during a high potential test or in certain situations with IT supplies and multiple generators there may be a requirement to disconnect the MOV protective ground connection. If the MOV protective ground connection is disconnected the immunity of the field controller to high voltage pulses is reduced. It is then only suitable for use with supplies having overvoltage category II, i.e. not for connection at the origin of the low voltage supply within a building. If the MOV to protective ground connection is not required then do not make a protective ground connection to the FXMP25.

4.4 Line reactors

The FXMP25, in common with all naturally commutated SCR drives, causes voltage notches at the input supply terminals. To avoid disturbances with other equipment using the same supply, the addition of external line inductance is strongly recommended in order to restrict the depth of notches imposed. This is generally not necessary where a dedicated transformer is used to supply the FXMP25.

The following recommendations for added line inductance, have been calculated based on the power drive systems standard: EN 61800-3:2004 "Adjustable speed electrical power drive systems - Part 3: EMC requirements and specific test methods".

Table 4-1 Minimum values of L_{add} and inductor current rating for a typical application

Field output current	System voltage		Typical current rating
	400 V	480 V	
A	μ H	μ H	A
25	230	290	26

NOTE

On typical field windings or high inductance loads the output current is smooth DC and therefore the rms input current is approximately equal to the DC output current. The above assumes the supply has 1.5 % impedance and a minimum supply rating of 5 kA.



Control of current below 250 mA (thyristor holding currents) should be avoided. If control at this level is required then line reactors must be installed to reduce the effect of dv/dt as thyristors turn off.

4.5 Cable and fuse size ratings



The selection of the correct fuse is essential to ensure the safety of the installation.



The AC supply inputs in the FXMP25 controller are fitted with auxiliary fuses for protection against short circuits in the FXMP25 controller and field-winding of the motor. These fuses will not protect the supply cables to the FXMP25 controller. There are other fuses suggested to install in branch circuits. The branch circuit fuses will protect the supply cables to the FXMP25 controller. This section shows recommended cable sizes and fuse ratings for a number of current levels. Failure to observe this recommendation will cause a risk of fire.



Wiring must be in accordance with local regulations and codes of practice. The table shows typical cable sizes for power input and output wiring. In the event of a conflict, local regulations prevail.

Maximum continuous input currents are given in section 2.1 *Ratings* on page 9 to aid the selection of fuses and cabling.

The cable sizing selected when installing the FXMP25 must comply with local wiring regulations. The information provided in this section is for guidance purposes only.

The power terminals on the FXMP25 are designed to accommodate a maximum cable size of 5.26 mm² (10 AWG).

The actual size depends on a number of factors including:

- Actual maximum continuous current
- Ambient temperature
- Cable support, method and grouping
- Cable voltage drop

Where continuous field current is reduced, the cable sizing selected can be appropriate for the reduced current. The field controller parameters should be programmed with the correct values.

NOTE

When using reduced cable sizes, the branch circuit protection fuse rating needs to be reduced in line with the cable size selected.

Table 4-2 gives examples of the cable sizes based on IEC 60364-5-52 and UL508C/NEC. The example cable sizes below assume three current-carrying conductors per cable or raceway and 40 °C ambient temperature.

Table 4-2 Typical cable sizes

	IEC 60364-5-52 ^[1]	UL508C/National Electrical Code ^[2]
Input/Output	4 mm ²	10 AWG

1. Assumes the use of XLPE or EPR insulated cables in mounting method B2 as per Table B52.5.
2. Assumes the use of 75 °C copper cable as per table 310.16 of the National Electrical code.

4.5.1 Armature connections A1 A2

Connection to A1, A2 is only required in stand alone mode for voltage monitoring of the armature voltage during field weakening. Armature branch fuses should be located close to the armature supply and sized to protect the cable from the fuses to the FXMP25. Cables 0.5 mm² to 5.26 mm² (22 AWG to 10 AWG) should be used.

4.5.2 Fusing for FXMP25

Table 4-3 Ferraz Shawmut internal semiconductor fusing*

Fuse type	Rating Vac	Rating A	Catalog number	Ref number
10 x 38 mm ferrule	690	30	FR10GB69V30	M330015

*Internal semiconductor fusing is for protection of SCR / thyristor bridge only.

Table 4-4 Ferraz Shawmut supply branch circuit protection fusing

Fuse type	Rating Vac	Rating A	Catalog number	Ref number	UL Class J alternative
14 x 51 mm ferrule	500	32	FR14GG50V32	W216656	

Table 4-5 Cooper Bussman supply branch circuit protection fusing

Fuse type	Rating Vac	Rating A	Catalog number
10.3 x 38 mm ferrule	600 V	30	LP-CC-30

Table 4-6 Siba supply branch circuit protection fusing

Fuse type	Rating Vac	Rating A	Catalog number
NH 000 knife blade	690 V	32	20 477 13.32

NOTE

Recommended fuses are based on rated current operation. Supply branch circuit protection is required for cable and internal control electronics protection.

4.5.3 Internal semiconductor fuses

The internal semiconductor fuses provide protection to the FXMP25 SCR / thyristor bridge only. The fuses can rupture if there is a fault in the field circuit. The user should check the internal semiconductor fuses if the FXMP25 is tripping field loss (FdL) while enabled.

**Electric shock risk**

If the FXMP25 controller has been energized, the supply must be isolated for at least five minutes. This allows the internal capacitors to discharge fully before work may commence.



Isolate the power before removing the internal semiconductor fuses.

Figure 4-2 Removing the internal semiconductor fuses

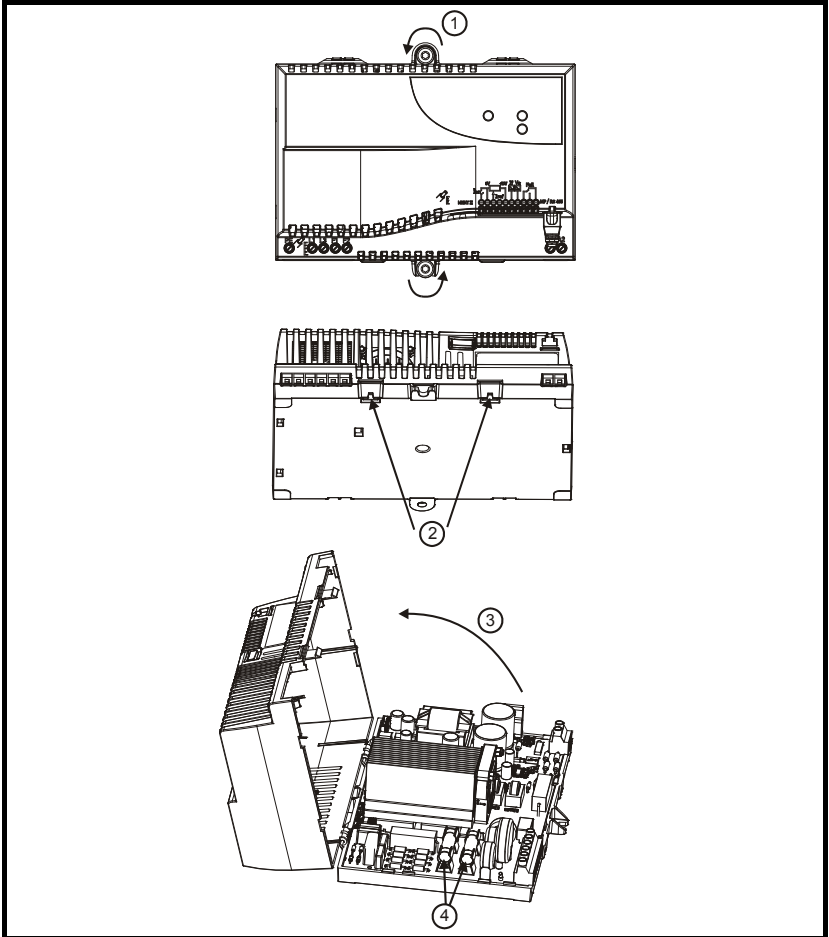

1. Remove mounting screws (M6 recommended).
2. Apply pressure at the two points shown on the bottom of the FXMP25 to release the terminal cover clips.
3. Open the terminal cover in the direction shown.
4. Remove the internal semiconductor fuses.

4.6 EMC (Electromagnetic compatibility)

The FXMP25 meets immunity requirements (specified in section 8.17 *Electromagnetic compatibility (EMC)* on page 58) with no special precautions.

NOTE

Some special measures may be required in certain applications where the control cables are long or pass outside the building. See section 4.6.1 *Surge immunity of control circuits - long cables and connections outside a building* on page 22.

Radio frequency noise emission can occur from any of the power connections i.e. AC supply and field output terminals.

For many applications in heavy industrial environments the noise emission is not sufficient to cause interference to other equipment.

When radio frequency emission must be limited an input EMC filter can be installed. Shielded cables must be used for the field and the shield must be clamped to grounded metallic parts at both ends. The standard is met for cable lengths up to 100m.

Table 4-7 FXMP25 emission compliance

Filter *	Conformity
No filter	C4
Schaffner FN3280H-25-33	C2

* Filters can be sourced directly from Schaffner.

Key (shown in decreasing order of permitted emission level):

C4 EN 61800-3:2004 second environment, restricted distribution (Additional measures may be required to prevent interference).

C2 Industrial generic standard EN 61000-6-4:2007.
EN 61800-3:2004 first environment restricted distribution (The following caution is required by EN 61800-3:2004).



The recommended filter has been selected to be compatible with the SCR control circuit in the FXMP25 unit. It is strongly recommended that no other filter type be used. SCRs can be damaged by filters with unsuitable output impedance (capacitors connected directly to the output).



The filter must be used in conjunction with a suitable RFI filter for the armature supply. The filter input must obtain its supply from the input of the armature filter and line chokes, otherwise it may be over-heated and possibly damaged by the armature voltage notching.



This is a product of the restricted distribution class according to IEC 61800-3. In a residential environment this product may cause radio interference in which case the user may be required to take adequate measures.

EN 61800-3:2004 defines the following:

- The first environment is one that includes residential premises. It also includes establishments directly connected without intermediate transformers to a low-voltage power supply network which supplies buildings used for residential purposes.
- The second environment is one that includes all establishments other than those directly connected to a low-voltage power supply network which supplies buildings used for residential purposes.
- Restricted distribution is defined as a mode of sales distribution in which the manufacturer restricts the supply of equipment to suppliers, customers or users who separately or jointly have technical competence in the EMC requirements of the application of drives.

4.6.1 Surge immunity of control circuits - long cables and connections outside a building

The input/output ports for the control circuits are designed for general use within machines and small systems without any special precautions.

In applications where they may be exposed to high-energy voltage surges, some special measures may be required to prevent malfunction or damage. Surges may be caused by lightning or severe power faults in association with grounding arrangements which permit high transient voltages between nominally grounded points. This is a particular risk where the circuits extend outside the protection of a building.

As a general rule, if the circuits are to pass outside the building where the drive is located, or if cable runs within a building exceed 30 m, some additional precautions are advisable. One of the following techniques should be used:

1. Galvanic isolation, i.e. do not connect the control 0 V terminal to ground. Avoid loops in the control wiring, i.e. ensure every control wire is accompanied by its return (0 V) wire.
2. Shielded cable with additional power ground bonding. The cable shield may be connected to ground at both ends, but in addition the ground conductors at both ends of the cable must be bonded together by a power ground cable (equipotential bonding cable) with cross-sectional area of at least 10 mm², or 10 times the area of the signal cable shield, or to suit the electrical safety requirements of the plant. This ensures that fault or surge current passes mainly through the ground cable and not in the signal cable shield. If the building or plant has a well-designed common bonded network this precaution is not necessary.
3. Additional over-voltage suppression - for the analog and digital inputs and outputs, a zener diode network or a commercially available surge suppressor may be connected in parallel with the input circuit as shown in Figure 4-3 and Figure 4-4.

Figure 4-3 Surge suppression for digital and unipolar inputs and outputs

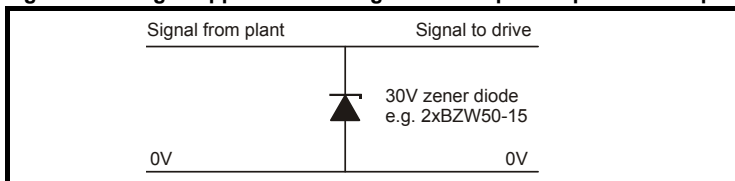
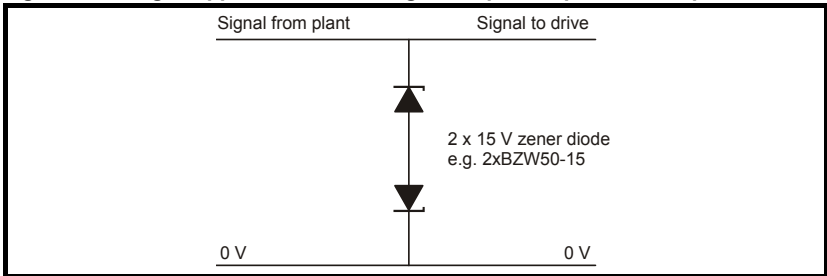

Figure 4-4 Surge suppression for analog and bipolar inputs and outputs



Surge suppression devices are available as rail-mounting modules, e.g. from Phoenix Contact:

Unipolar TT-UKK5-D/24 DC

Bipolar TT-UKK5-D/24 AC

4.7 Control terminal specification

Figure 4-5 Control terminals

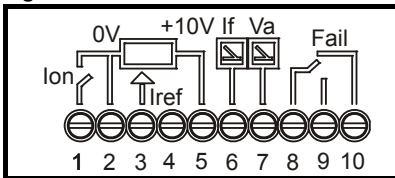

1 (Ion)	Digital input
Dual Function	Field economy select or enable controller (See Pr 81)
Type	Single ended, negative logic (0 V common for normal operation)
Voltage range	0 V to 24 V
Absolute maximum applied voltage range	-18 V to 30 V
Load	2.4 mA at 0 V (sink)
Input threshold	High: 11 V, Low: 9 V
Update rate	4 ms

2 (0V)	0V common
Function	Common connection for all external devices

3 (Iref)	Analog input
Function	Current demand input
Full scale voltage range	0 to 10 V
Absolute maximum voltage range	-18 V to 30 V
Input resistance	44 kΩ
Resolution	10 bits
Sample period	4 ms

4	Not used
----------	-----------------

5 (+10V)	10V user output
Function	Supply for Analog input terminal
Voltage tolerance	2 %
Rated output current	5 mA
Protection	Over 5 mA, the current is limited, but there is no trip (Voltage is less than 10 V if the current is higher than 5 mA)

6 (If)	Field current output signal
7 (Va)	Armature voltage output signal
Type	Single-ended voltage
Voltage range	0 to 10 V
Maximum output current	5 mA
Load resistance	2 k Ω min
Protection	5 mA short circuit protection
Resolution	10 bits
Update period	4 ms

8	Fail relay common
9	Fail relay normally open
10	Fail relay normally closed
Function	FXMP25 OK indicator (See Pr 01 and Pr 27.
Type	Form C
Rating	250/125 Vac category 1/2 5 A nominal resistive load 5 A 30 Vdc
Contact condition	Energized when power applied and FXMP25 OK
Update period	4 ms



Status relay contact is over-voltage category II.

4.8 Serial communications

4.8.1 Introduction

The FXMP25 has a standard 2-wire EIA485 interface (serial communications interface) which enables all drive set-up, operation and monitoring to be carried out with a PC or controller if required. Therefore it is possible to control the drive entirely by serial communications without the need for a keypad or other control cabling.

The drive supports Modbus RTU configured as the default protocol, which is used with the PC-tools commissioning/start-up software as provided on the CD ROM with the product.

The serial communications port of the drive is a RJ45 socket, which is isolated from the power stage.

The communications port applies a 2 unit load to the communications network.

4.8.2 Serial communications connections

The FXMP25 has a serial communications port (serial port) as standard supporting two wire EIA(RS)-485 communications. See Table 4-8 for the connection details for the RJ45 connector.

Figure 4-6 Serial communications port

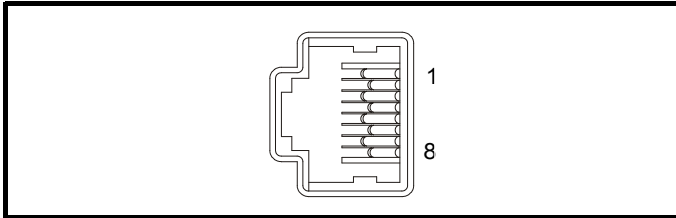

Table 4-8 RJ45 connections

Pin	Function
1	120 Ω Termination resistor
2	RX TX
3	0 V isolated
4	+24 V (100 mA)
5	0V isolated
6	TX enable
7	RX\ TX\
8	RX\ TX\ (if termination resistors are required, jumper (link) to pin 1)
Shell	0 V isolated

The communications port applies a two-unit load to the communications network. Connectors 2, 3, 7 and shield must always be made to the serial communications port. Shielded cable must be used at all times.

USB/EIA232 to EIA485 Communications

An external USB/EIA232 hardware interface such as a PC cannot be used directly with the 2-wire EIA485 interface of the drive. Therefore a suitable converter is required.

Suitable USB to EIA485 and EIA232 to EIA485 isolated converters are available from Control Techniques as follows:

- CT USB Comms cable (CT Part No. 4500-0096)
- CT EIA232 Comms cable (CT Part No. 4500-0087)

When using one of the above converters or any other suitable converter with the FXMP25, it is recommended that no terminating resistors be connected on the network. It may be necessary to 'link out' the terminating resistor within the converter depending on which type is used. The information on how to link out the terminating resistor will normally be contained in the user information supplied with the converter.

4.8.3 Serial communications set-up parameters

The following parameters need to be set according to the system requirements.

This parameter defines the communications protocol used by the 485 comms port on the drive. This parameter can be changed via the drive keypad, via a Solutions Module or via the comms interface itself. If it is changed via the comms interface, the response to the command uses the original protocol. The master should wait at least 20 ms before sending a new message using the new protocol. (Note: ANSI uses 7 data bits, 1 stop bit and even parity; Modbus RTU uses 8 data bits, 2 stops bits and no parity).

NOTE

When using the CT EIA232 Comms cable the available baud rate is limited to 19.2 k baud.

Parameters Pr **95** and Pr **96** select the address and baud rate respectively as detailed in section 6 *Parameters* on page 30.

5 Getting started

5.1 Keypad and display

The display will show different information depending on the display mode selected. There are three display modes as shown below.

Figure 5-1 Display modes

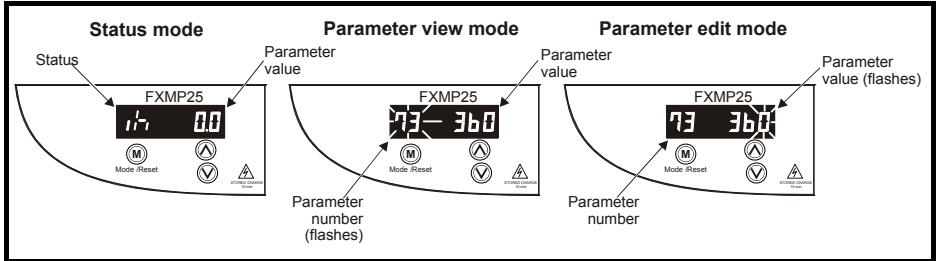
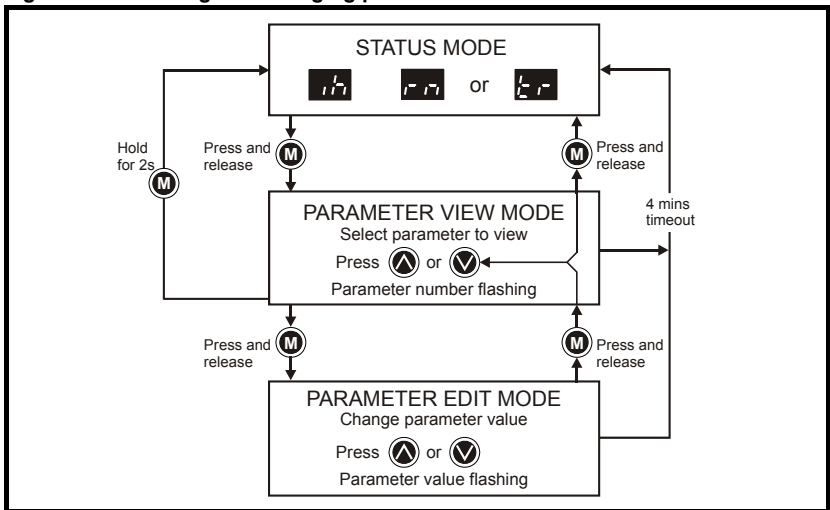











Figure 5-2 Selecting and changing parameters





When in status mode pressing and releasing the **M** MODE key will change the display from status mode to parameter view mode.

In parameter view mode, the left hand display flashes the parameter number and the right hand display shows the value of that parameter. The left hand display flashing indicates that the **▲** up and **▼** down keys will select a different parameter to be viewed. Holding the **▲** up key will cause the parameter number to increment to Pr 99.

A single up  key action when the last parameter is being displayed will cause the parameter number to roll over to the lowest parameter available in the current mode. Similarly holding the  down key will cause the parameter number to decrement until the lowest parameter available is reached and a single  down key action will cause the parameter number to roll under to Pr 99. Pressing and releasing the  Mode key again will change the display from parameter view mode to parameter edit mode. In parameter edit mode, the right hand display flashes the value in the parameter being shown in the left hand display.

Pressing the  MODE key in parameter edit mode will return the controller to parameter view mode. If the  MODE key is pressed again then the controller will return to status mode, but if either of the  up or  down keys are pressed to change the parameter being viewed before the  MODE key is pressed, pressing the  MODE key will change the display to parameter edit mode again. This allows the user to easily change between parameter view and edit mode while setting up the field controller.

Pressing the up  and  down keys simultaneously when editing a parameter will set the value to zero immediately.

If no action is made while in parameter view or edit mode for 4 minutes the status mode is entered automatically.

5.2 Resetting the field controller



The controller can be reset using the keypad by pressing the  mode key for at least two seconds in status or parameter view mode.

A reset is required in response to the following conditions:

- To reset the controller from a tripped state
- To implement a change in the value of certain parameters

5.3 Security

In the field controller's default state no security is implemented, and any R/W parameter can be adjusted. If Pr 98 (user security code) is set to any value other than 0, then the value programmed will be taken as a security code. With a security code programmed, on power up, no R/W parameter can be altered. It will not be possible to change any parameter without first entering the security code. If Pr 98 is selected for viewing when a security code has been programmed the value indicated will be 0 (to prevent the code programmed from being read).

When a security code has been programmed, any attempt to enter edit mode will cause the field controller to flash 'Code' on the 4 digit display to prompt the user for a security code (providing the parameter is R/W and not R/O). When the  Up or  Down keys are pressed, the 4 digit display will then show the code being adjusted and the 2 digit display will indicate 'Co'. On setting the code, the user presses the  MODE key. If the correct code has been entered then the field controller will switch to parameter edit mode on the parameter the user had selected to edit, but if the correct code has not been entered the field controller will return to parameter view mode.

5.4 Setting the controller back to default values



If Pr 00 is set to a non-zero value and edit mode is exited, the field controller is reset when the field controller is inactive (Pr 77= OFF), the selected default parameters will automatically be loaded. After the parameters have been set to default values, they are automatically saved to the field controller's EEPROM on power down. New values will take effect on subsequent power up.

Table 5-1 Pr 00 settings

Value	Display	Function
0	nonE	No action
1	Eur	Load European defaults
2	USA	Load USA defaults

NOTE If loading default when the drive is active, the display will flash FAIL once and then Pr 00 will be change back to nonE.

Table 5-2 Status modes

Left hand display	Status	Explanation
	Field controller inhibited	The field controller is inhibited because the field controller is disabled (Pr 77 = OFF).
	Field controller has tripped	The field controller has tripped. The trip code will be displayed in the 'right hand' display (see Chapter 9 <i>Diagnostics</i> on page 60).
	Field controller is running	The field controller is in a run state. Pr 78 = Mode Selected an Pr 77=On Standalone Mode or Mentor MP Pr 5.77=On in MP Mode or Mentor II ribbon cable is connected in Mentor II mode.

To set defaults from MP or MII Mode, set Pr 78 = OFF then press  to exit edit mode. A power cycle is then required to gain access to Pr 00.

5.5 Saving parameters

Parameters are automatically saved when the  MODE key is pressed when going from parameter edit mode to parameter view mode.

NOTE A parameter change is not saved if a drive trip occurs when the parameter is changed.

6 Parameters

All parameters are available in default Pr 78 = OFF (0)

In the table below the abbreviations used in the table have the following meaning:

MP - In Mentor MP mode the field controller is being controlled by Mentor MP.

MII - In Mentor II mode the field controller is being controlled by Mentor II.

ST - In Stand alone mode the field controller is controlled by itself.

Table 6-1 Quick look-up parameter table

Pr	Description	MP	MII	ST
00	Loading defaults			✓
01	FXMP25 OK	✓	✓	✓
02	Armature voltage			✓
03	Flux reference			✓
04	Flux reference input offset			✓
05	Flux reference scaling			✓
06	Armature voltage output scaling			✓
07	Field flux output scaling	✓	✓	✓
11	Field current feedback scaling		✓	
12	Autotune			✓
25	FXMP25 OK flux level		✓	✓
26	FXMP25 OK hysteresis level		✓	✓
27	Flux threshold level exceeded		✓	✓
29	Motor saturation breakpoint 1			✓
30	Motor saturation breakpoint 2			✓
54	Flux feedback	✓	✓	✓
55	Flux / voltage demand			✓
56	Field current feedback	✓	✓	✓
57	Percentage voltage demand			✓
58	Field firing angle			✓
59	Field weakening voltage set point			✓
60	Field output voltage			✓
62	Field weakening loop P gain			✓
63	Field weakening loop I gain			✓
64	External flux reference select			✓

Pr	Description	MP	MII	ST
67	Field economy level			✓
68	Maximum flux / voltage limit			✓
69	Minimum flux / voltage limit			✓
70	Rated field current			✓
71	Flux loop P gain			✓
72	Flux loop I gain			✓
73	Rated field voltage			✓
74	Rated field compensation factor			✓
75	Field voltage mode select			✓
76	AC supply	✓		✓
77	Enable field control			✓
78	Field mode	✓	✓	✓
80	Economy level selected			✓
81	Digital input control			✓
90	Trip 0	✓	✓	✓
91	Trip 1	✓	✓	✓
92	Trip 2	✓	✓	✓
93	Trip 3	✓	✓	✓
94	Parameter displayed at power up			✓
95	Serial address			✓
96	Baud rate			✓
97	Software version	✓	✓	✓
98	User security code	✓	✓	✓
99	Power software version	✓	✓	✓

Parameter numbers are numbered so they match Mentor MP menu 5 parameters.

For example Pr 77 FXMP=Pr 5.77 on Mentor MP

6.1 Full parameter descriptions

Table 6-2 Key to parameter coding

Coding	Attribute
Bit	1 bit parameter
FI	Filtered: some parameters which can have rapidly changing values are filtered when displayed on the drive keypad for easy viewing.
Txt	Text: the parameter uses text strings instead of numbers.
VM	Variable maximum: the maximum of this parameter can vary.
DP	Decimal place: indicates the number of decimal places used by this parameter.
ND	No default: when defaults are loaded (except when the drive is manufactured or on EEPROM failure) this parameter is not modified.
US	User save: saved in drive EEPROM when the user initiates a parameter save.
RW	Read/write: can be written by the user.
BU	Bit default one/unsigned: Bit parameters with this flag set to one have a default of one (all other bit parameters have a default of zero. Non-bit parameters are unipolar if this flag is one.
PS	Power-down save: parameter automatically saved in drive EEPROM when the under volts (UV) trip occurs. Power-down save parameters are also saved in the drive when the user initiates a parameter save.

00	Loading defaults										
Coding	Bit	FI	Txt	VM	DP	ND	US	RW	BU	PS	
Range	nonE(0), Eur(1), USA(2)										
Update rate	Actioned on exit of edit mode or FXMP25 reset										

If this parameter is set to a non-zero value and edit mode is exited or the FXMP25 is reset when the FXMP25 is inactive, the selected default parameters will automatically be loaded. After the parameters have been set to default values they are automatically saved to the FXMP25's internal EEPROM on power down. New values will take effect on subsequent power up.

Value	Display	Function
0	nonE	No action
1	Eur	Load European defaults
2	USA	Load USA defaults

01	FXMP25 OK										
Coding	Bit	FI	Txt	VM	DP	ND	US	RW	BU	PS	
Range	OFF (0) or On (1)										
Update rate	Background										

Indicates the FXMP25 is not in the trip state.

02	Armature voltage										
Coding	Bit	FI	Txt	VM	DP	ND	US	RW	BU	PS	
		1				1			1		
Range	0 to 860 V										
Update rate	Background write										

The average measured DC input voltage seen across the field controller A1 and A2 terminals.

03	Flux reference										
Coding	Bit	FI	Txt	VM	DP	ND	US	RW	BU	PS	
		1			1	1			1		
Range	0.0 to 100.0 %										
Update rate	Background										

This parameter displays the level of the analog signal present at the flux reference input, this is a unipolar voltage input where the input range is 0 V to +10 V.

04	Flux reference input offset										
Coding	Bit	FI	Txt	VM	DP	ND	US	RW	BU	PS	
					1		1	1			
Range	±100 %										
Default	0.0										
Update rate	Background read										

An offset can be added to flux reference input with a range from -100.0 % to 100.0 %. If the sum of the input and the offset is outside the range 0 to 100 % the result will be clamped at 0 or 100 %.

05	Flux reference scaling										
Coding	Bit	FI	Txt	VM	DP	ND	US	RW	BU	PS	
					3		1	1	1		
Range	0.000 to 4.000										
Default	1.000										
Update rate	Background										

The flux reference input is connected to the field economy parameter when the flux input is selected. The maximum value of the field economy is 100 % and so the default for the scaling parameter is 1 so that the demand is 100 % for 10 V input.

06	Armature voltage output scaling										
Coding	Bit	FI	Txt	VM	DP	ND	US	RW	BU	PS	
					3		1	1	1		
Range	0.000 to 4.000										
Default	1.000										
Update rate	Background										

The maximum value of Pr 02 is 860 which without any scaling will be converted to 10 V. This parameter should be adjusted by the user for other full scale voltages.

07	Field flux output scaling									
Coding	Bit	Fl	Txt	VM	DP	ND	US	RW	BU	PS
					3		1	1	1	
Range	0.000 to 4.000									
Default	1.500									
Update rate	Background									

The default value of 1.500 will produce 10 V output on the analog output (terminal 6) when the feedback is at 100 % (Pr **54** Flux Feedback).

11	Field current feedback scaling									
Coding	Bit	Fl	Txt	VM	DP	ND	US	RW	BU	PS
							1	1	1	
Range	0 to 20									
Default	10									
Update rate	Background									

This parameter must be set to the same value as Pr **6.11** on Mentor II when used with Mentor II. It defines the full scale current in amps.

NOTE

This parameter must be set before Pr **78** is selected for Mentor II mode. If already in Mentor II mode [Pr **78** = 2.H (2) or 2.F (3)] a power cycle is required before the new values will take effect.

12	Autotune									
Coding	Bit	Fl	Txt	VM	DP	ND	US	RW	BU	PS
	1							1		
Range	OFF (0) or On (1)									
Default	OFF (0)									
Update rate	Background read									

In stand alone mode, setting this parameter will instruct the field controller to set-up its flux loop gains automatically. If any voltage is detected on the armature voltage input during the autotune then the unit will trip.

At the end of the autotune routine, Pr **77** is set to 0 (off) when Pr **81** = 0. If Pr **81** = 1, then the controller remains in the enabled condition as controlled by the digital input.

25	FXMP25 OK flux level									
Coding	Bit	Fl	Txt	VM	DP	ND	US	RW	BU	PS
					1		1	1	1	
Range	0.0 to 100.0 %									
Default	6.7 %									
Update rate	16 ms									

This parameter sets the level at which field loss is detected and operates the fail relay in Mentor II and standalone mode 100 % level = 150 % flux. 10 % flux / 1.5 = 6.7 the same level as FXM5.

26		FXMP25 OK hysteresis level									
Coding	Bit	Fl	Txt	VM	DP	ND	US	RW	BU	PS	
						1		1	1	1	
Range	0.0 to 25.0 %										
Default	0.0 %										
Update rate	16 ms										

Set the hysteresis from the level set in Pr **25** to eliminate relay bounce when the level is reached. If the value is greater or equal to the threshold Pr **25** plus half the hysteresis band Pr **26** the output becomes active, or if the value is less than the threshold minus half the hysteresis the output becomes inactive.

27		Flux threshold level exceeded									
Coding	Bit	Fl	Txt	VM	DP	ND	US	RW	BU	PS	
		1					1				
Range	OFF (0) or On (1)										
Update rate	16 ms										

When set to On (1) indicates the value of flux is above threshold levels set by Pr **25** and Pr **26**.

29		Motor saturation breakpoint 1									
Coding	Bit	Fl	Txt	VM	DP	ND	US	RW	BU	PS	
								1	1	1	
Range	0 to 100 % of rated flux										
Default	50										
Update rate	Background read										

See Pr **30** for description.

30		Motor saturation breakpoint 2									
Coding	Bit	Fl	Txt	VM	DP	ND	US	RW	BU	PS	
								1	1	1	
Range	0 to 100 % of rated flux										
Default	75										
Update rate	Background read										

When the motor is operating in the field weakening voltage loop region the relationship between the field current and the level of flux can be non linear. The field controller can include the effects of this non linearity by representing the field current to flux characteristic as a series of three lines as shown in the figure overleaf.

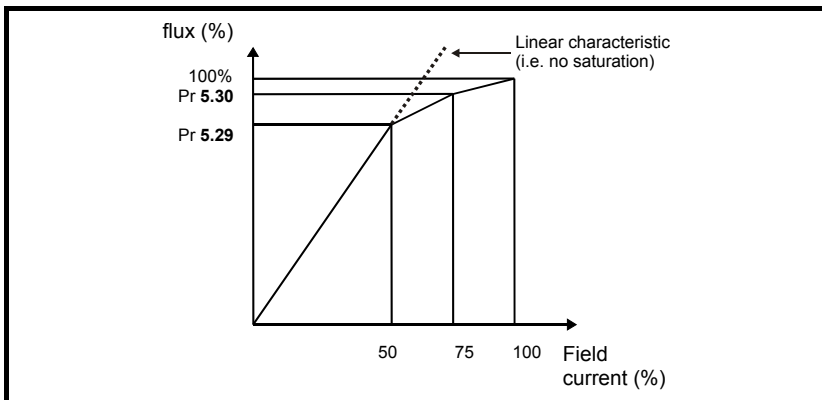

If Pr 29 and Pr 30 have their default values of 50 and 75, the characteristic becomes one line and there will be a linear relationship between the field controller estimate of flux and the field current. If Pr 29 and Pr 30 are increased above 50 and 75 the field controller estimate of flux can include the effect of the non linearity. It is unlikely that information will be available to set-up these parameters, and so the values are determined during the rotating autotune test (in Mentor MP mode only). To set these values in stand alone mode use the following procedure:

- Ensure that Pr 29, Pr 30, Pr 68 and Pr 74 are set to their default values of 50 %, 75 %, 100 % and 100 % respectively.
- Set the speed demand to 1/4 of *Base speed* and run the machine up to speed and check the speed of the machine using a hand held device.
- If the machine speed is lower than 1/4 of *Base speed* (which is normally the case) adjust the *Field compensation factor* (Pr 74) down until the correct machine speed is reached. If the machine speed is higher than 1/4 of *Base speed* (only possible if the motor nameplate field current is low), adjust the *Rated field current* (Pr 70) up until the correct machine speed is reached.
- Set Pr 68 *Maximum flux* to 75 % and measure the actual speed of the machine (speed 75)
- Set Pr 68 *Maximum flux* to 50 % and measure the actual speed of the machine (speed 50).
- Stop the machine and set Pr 68 *Maximum flux* back to 100 %.
- Set Pr 29 *Motor saturation breakpoint 1* = 50 x set speed / actual speed (Speed 50)
- Set Pr 30 *Motor saturation breakpoint 2* = 75 x set speed / actual speed (speed 75).
- Press mode to save parameters.

54		Flux feedback									
Coding	Bit	Fl	Txt	VM	DP	ND	US	RW	BU	PS	
			1			1	1				
Range	±150.0 %										
Update rate	Background write										

Flux feedback after the current to flux converter, see motor saturation breakpoints in Table 6-1 *Quick look-up parameter table* on page 30.

55		Flux / voltage demand									
Coding	Bit	Fl	Txt	VM	DP	ND	US	RW	BU	PS	
			1			1	1				
Range	±120.0 %										
Update rate	Mains period / 6 ms										

When in current mode the flux demand from the field weakening voltage loop, subject to the limits of Pr **68** and Pr **69**. When in voltage mode [Pr **75** = On (1)] the voltage demand is subject to the limits of Pr **68** and Pr **69**.

56		Field current feedback									
Coding	Bit	Fl	Txt	VM	DP	ND	US	RW	BU	PS	
			1			2	1				
Range	±25.00 A										
Update rate	Background write										

The current feedback in amps.

57		Percentage voltage demand									
Coding	Bit	Fl	Txt	VM	DP	ND	US	RW	BU	PS	
			1			1	1				
Range	±150.0 % (0 to150 % in half control mode)										
Update rate	Background write										

Indicates percentage voltage demand. Negative value in full control indicates energy absorption to force field down quicker.

58		Field firing angle									
Coding	Bit	Fl	Txt	VM	DP	ND	US	RW	BU	PS	
			1			1	1				
Range	0.0 to 180.0 °										
Update rate	Background write										

0 ° = fully phased forward full volts applied to the field.

59	Field weakening voltage set point									
Coding	Bit	FI	Txt	VM	DP	ND	US	RW	BU	PS
								1	1	1
Range	0 to 750 V									
Default	Eur: 400, USA: 480									
Update rate	Background write									

The programmable value of the armature back emf or armature voltage (standalone mode), in volts, at which the field begins to weaken. Defined as the voltage at which base speed is reached.

60	Field output voltage									
Coding	Bit	FI	Txt	VM	DP	ND	US	RW	BU	PS
			1				1			
Range	0 to 500 V									
Update rate	Background write									

The calculated voltage being generated on the field output terminals. Calculated from applied mains voltage and firing angle.

62	Field weakening loop P gain									
Coding	Bit	FI	Txt	VM	DP	ND	US	RW	BU	PS
						2		1	1	1
Range	0.00 to 99.99									
Default	0.40									
Update rate	Background read									

Gains used during field weakening. Setting these too high could cause instability during field weakening.

63	Field weakening loop I gain									
Coding	Bit	FI	Txt	VM	DP	ND	US	RW	BU	PS
						2		1	1	1
Range	0.00 to 99.99									
Default	5.00									
Update rate	Background read									

Gains used during field weakening. Setting these too high could cause instability during field weakening.

64	External flux reference select									
Coding	Bit	FI	Txt	VM	DP	ND	US	RW	BU	PS
								1	1	
Range	OFF (0) to On (1)									
Default	OFF (0)									
Update rate	Background read									

When this parameter is set to OFF (0) the field controller operates with the field weakening voltage loop. When set to On (1) the flux level is determined by reference on terminal 3.

Safety information

Product information

Mechanical installation

Electrical installation

Getting started

Parameters

Setting-up

Technical data

Diagnostics

UL listing information

67		Field economy level									
Coding	Bit	FI	Txt	VM	DP	ND	US	RW	BU	PS	
						1		1	1	1	
Range	0.0 to 100 %										
Default	25.0 %										
Update rate	Background read										

In standalone mode, if the field controller is to be used in flux mode Pr **64** = On (1), this parameter would become the external flux reference of the field control loop.

When Pr **64** = OFF (0), this is the reference selected when terminal I_{on} is open.

68		Maximum flux / voltage limit									
Coding	Bit	FI	Txt	VM	DP	ND	US	RW	BU	PS	
					1	1		1	1	1	
Range	0 to MAX_FIELD_FLUX										
Default	100.0 %										
Update rate	Background read										

Programmable value of the maximum flux demand of the field weakening voltage loop. The maximum value of this parameter depends upon the setting of the rated current Pr **70**.

MAX_FIELD_FLUX = 100 x 25 / Pr **70**. For values of Pr **70** less than 20.8 A the MAX_FIELD_FLUX will be limited to 120 %.

Maximum voltage demand when field voltage mode is selected Pr **75** = On (1).

69		Minimum flux / voltage limit									
Coding	Bit	FI	Txt	VM	DP	ND	US	RW	BU	PS	
					1	1		1	1	1	
Range	0.0 to MAX_FIELD_FLUX										
Default	50.0 %										
Update rate	Background read										

The minimum value of flux demand to prevent excessive field weakening, and hence over speeding. Minimum voltage demand when field voltage mode is selected Pr **75** = On (1).

70		Rated field current									
Coding	Bit	FI	Txt	VM	DP	ND	US	RW	BU	PS	
						2		1	1	1	
Range	0.00 to 25.00A										
Default	Eur: 5.00, USA: 25.00										
Update rate	Background read										

This parameter will be set to the field current of the motor and will define the 100 % point for the field controller.

71	Flux loop P gain									
Coding	Bit	Fl	Txt	VM	DP	ND	US	RW	BU	PS
					2		1	1	1	
Range	0 to 30.00									
Default	3.00									
Update rate	Background read									

Increasing this parameter will allow the loop to track the current demand more closely. Setting the value too high will result in instability.

72	Flux loop I gain									
Coding	Bit	Fl	Txt	VM	DP	ND	US	RW	BU	PS
					1		1	1	1	
Range	0.00 to 300.0									
Default	60.0									
Update rate	Background read									

Increasing this parameter will allow the loop to track the flux demand more closely. Setting the values too high will result in instability.

73	Rated field voltage									
Coding	Bit	Fl	Txt	VM	DP	ND	US	RW	BU	PS
							1	1	1	
Range	0 to 500 V									
Default	Eur: 360, USA: 300									
Update rate	Background read									

This parameter should be set to the rated field voltage of the motor.

74	Rated field compensation factor									
Coding	Bit	Fl	Txt	VM	DP	ND	US	RW	BU	PS
							1	1	1	
Range	0 to 100 %									
Default	100 %									
Update rate	Background									

The name plate rated field current is normally quoted for a cold field. At this level of current, the machine is over-fluxed which causes the back EMF of the machine to be higher than expected. The parameter can be adjusted by monitoring the armature voltage while running at full speed. See Pr 30 on page 30 for further information.

75	Field voltage mode select									
Coding	Bit	FI	Txt	VM	DP	ND	US	RW	BU	PS
	1							1	1	
Range	OFF (0) to On (1)									
Default	Eur: OFF (0), USA: On (1)									
Update rate	Background read									

When this parameter is set to 1 the field controller operates in voltage mode. A fixed voltage is applied to the field rather than the current being regulated.

76	AC supply									
Coding	Bit	FI	Txt	VM	DP	ND	US	RW	BU	PS
			1				1			
Range	0 to 550 rms Vac									
Update rate	Background write									

The parameter indicates the average AC supply rms voltage at the input terminals. Filtered by a 100 ms first order filter.

77	Enable field control									
Coding	Bit	FI	Txt	VM	DP	ND	US	RW	BU	PS
	1			1				1	1	1
Range	OFF (0) to On (1)									
Default	OFF (0)									
Update rate	Background read									

When this parameter is set to OFF (0) the field controller is disabled. Setting this parameter to On (1) enables the field controller.

78	Field mode									
Coding	Bit	FI	Txt	VM	DP	ND	US	RW	BU	PS
				1				1	1	
Range	OFF(0),M P(1),2.H(2),2.F(3),St.H(4),St.F(5)									
Default	OFF (0)									
Update rate	Actioned on field controller reset									

Provide the option for operating mode and full or half bridge control

Pr 78 = 0--- No mode select (OFF)

Pr 78 = 1--- Mentor MP mode (M P)

Pr 78 = 2--- Mentor II mode, half control (2.H)

Pr 78 = 3--- Mentor II mode, full control (2.F)

Pr 78 = 4--- Stand alone, half control (St.H)

Pr 78 = 5--- Stand alone, full control (St.F)

A reset is required for the mode change to take effect and the command to be passed through to the power processor. A reset can be achieved by holding the mode key for 2 seconds.

NOTE

Once an operating mode has been setup the controller must be power cycled to change modes.

- Enter new mode in Pr 78
- Reset
- Power cycle

The new mode will then take effect.

NOTE When Mentor II modes [2.H (2) 2.F (3)] are required, Pr 11 must be set before Pr 78. If Pr 11 is changed after Pr 78 = 2.H (2) or 2.F (3), a power cycle is required before the new values will take effect.

Recommendations

Half control

Normally use half control, since this generally produces a lower amplitude of current ripple. This results in lower torque ripple in motor.

Full control

Full control causes the SCR bridge to force the field current more rapidly towards zero at each half cycle. This increases the amplitude of the current ripple, but gives faster control of the field current level. Use full control under the following conditions:

- When very rapid field weakening is required
- If the natural decay of the field defined by $\left(\frac{L}{R}\right)$ is slower than the acceleration required, then full field control is required.

NOTE Pr 78 can be changed while running between St.H (4) and St.F (5).

NOTE When controlling FXMP with Mentor MP, Mentor MP firmware must be V01.05.01 or later (Pr 11.29 = 01.05, Pr 11.34 = 1).

80	Economy level selected									
Coding	Bit	FI	Txt	VM	DP	ND	US	RW	BU	PS
		1	1				1			
Range	OFF (0) to On (1)									
Update rate	Background read									

Indicates that field economy level has been selected.

81	Digital input control									
Coding	Bit	FI	TE	VM	DP	ND	US	RW	BU	PS
				1				1	1	1
Range	Economy Level (0) or Enable Field Controller (1)									
Default	0									
Update rate	Background read									

Select the destination parameter of the digital input (terminal 1).

If Pr 81 = 0 (Eco), the digital input controls parameter Pr 80. This is inverted so Pr 80 is 'ON' by default.

If Pr 81 = 1 (F.Ctl), the digital input controls the parameter Pr 77.

Reset the drive for the change to take place.

90	Trip 0										
91	Trip 1										
92	Trip 2										
93	Trip 3										
Coding	Bit	FI	Txt	VM	DP	ND	US	RW	BU	PS	
			1			1			1	1	
Range	0 to 255										
Update rate	Background write										

Indicates the last four field controller trips.

94	Parameter displayed at power-up										
Coding	Bit	FI	Txt	VM	DP	ND	US	RW	BU	PS	
							1	1	1		
Range	00 to 98										
Default	54										
Update rate	Background read										

This parameter defines which parameter is displayed at power up. When the field controller enters status mode this parameter is also displayed.

95	Serial address										
Coding	Bit	FI	Txt	VM	DP	ND	US	RW	BU	PS	
							1	1	1		
Range	0 to 247										
Default	1										
Update rate	Background read										

Used to define the unique address for the field controller for the serial interface. The field controller is always a slave.

Addresses between 0 and 247 are permitted. Address 0 is used to globally address all slaves, and so this address should not be set in this parameter.

96	Baud rate										
Coding	Bit	FI	Txt	VM	DP	ND	US	RW	BU	PS	
			1				1	1	1		
Range	0 to 4										
Default	3										
Update rate	Background read										

Used to define the baud rate of the serial interface.

Parameter value	String/baud rate
0	2400
1	4800
2	9600
3	19200
4	38400

This parameter can be changed via the field controller keypad or via the comms interface itself. If it is changed via the comms interface, the response to the command uses the original baud rate. The master should wait at least 20ms before sending a new message using the new baud rate.

97	Software version									
Coding	Bit	Fl	Txt	VM	DP	ND	US	RW	BU	PS
					2	1			1	
Range	1.00 to 99.99									
Update rate	Write at power-up									

The field controller software version consists of two numbers xx.yy. Where xx specifies a change that affects hardware compatibility, yy specifies a change that affects product documentation.

98	User security code									
Coding	Bit	Fl	Txt	VM	DP	ND	US	RW	BU	PS
						1	1	1	1	
Range	0 to 999									
Default	0									
Update rate	Background read									

If any number other than 0 is programmed into this parameter, user security is applied so that no parameters can be adjusted. When this parameter is displayed and security is locked it appears as zero.

99	Power software version									
Coding	Bit	Fl	Txt	VM	DP	ND	US	RW	BU	PS
					2	1			1	
Range	1.00 to 99.99									
Update rate	Write at power-up									

The power PCB software version consists of two numbers xx.yy. Where xx specifies a change that affects hardware compatibility, yy specifies a change that affects product documentation.

7 Setting-up



The field current must not be allowed to become zero while the motor is running.



During the following procedure, you will be required to apply AC power to the FXMP25 controller and to run the motor. Before applying AC power, ensure the following:
The controller is correctly connected. The controller cover is securely installed. The motor can be run safely.

Table 7-1 Quick start commissioning / start up from defaults for stand alone mode

Action	Detail	
Before power up	<p>Ensure:</p> <ul style="list-style-type: none"> Motor field is connected. Armature feedback is connected to A1 and A2 connections if field weakening is required. <div style="border: 1px solid black; padding: 5px; margin-top: 10px;"> <p>The relay should be connected to the armature controller to indicate when a field controller has low field excitation. This will avoid an overspeed condition due to loss or reduced field excitation.</p> </div>	
Power up the field controller	<p>Ensure:</p> <ul style="list-style-type: none"> The field controller displays: If the field controller trips, see Chapter 9 Diagnostics on page 60. 	
Enter motor nameplate details	<p>From European defaults: Enter:</p> <ul style="list-style-type: none"> Field rated current in Pr 70 Field rated voltage in Pr 73 <p>From USA defaults: Enter:</p> <ul style="list-style-type: none"> Field rated voltage in Pr 73 	
Select field mode	<p>The following modes can be selected for stand alone mode:</p> <ul style="list-style-type: none"> Set Pr 78 (Field mode) = St.H (4) for stand alone, half control. Set Pr 78 (Field mode) = St.F (5) for stand alone, full control. Carry out a reset by pressing the mode button for at least 2 seconds 	
Autotune	<p>Autotune for flux loop gains (Not required in voltage mode {USA defaults})</p> <p>When this operation is performed the field controller sets up its flux loop gains, Flux loop P gain (Pr 71), Flux loop I gain (Pr 72) automatically.</p> <p>To perform an autotune:</p> <ul style="list-style-type: none"> Set Pr 12 (Autotune) = On (1) Set Pr 77 (Enable field control) = On (1) 	

Action	Detail	
Setting up for field weakening	If field weakening is required: From European defaults: <ul style="list-style-type: none"> • Set Pr 59 (Field weakening voltage set point) • Set Pr 69 (minimum flux / voltage limit) From USA defaults: <ul style="list-style-type: none"> • Set Pr 59 (Field weakening voltage set point) • Set Pr 69 (minimum flux / voltage limit) • Set Pr 70 (Field rated current) 	
Enable the field controller	To enable the field controller: <ul style="list-style-type: none"> • Set Pr 77 (Enable field control) = On (1) 	
Close field economy jumper	Close field economy input (I _{on}) so that Pr 80 (Economy level select) is OFF (0).	

Safety information

Product information

Mechanical installation

Electrical installation

Getting started

Parameters

Setting-up

Technical data

Diagnostics

UL listing information

Figure 7-1 Standalone mode logic diagram

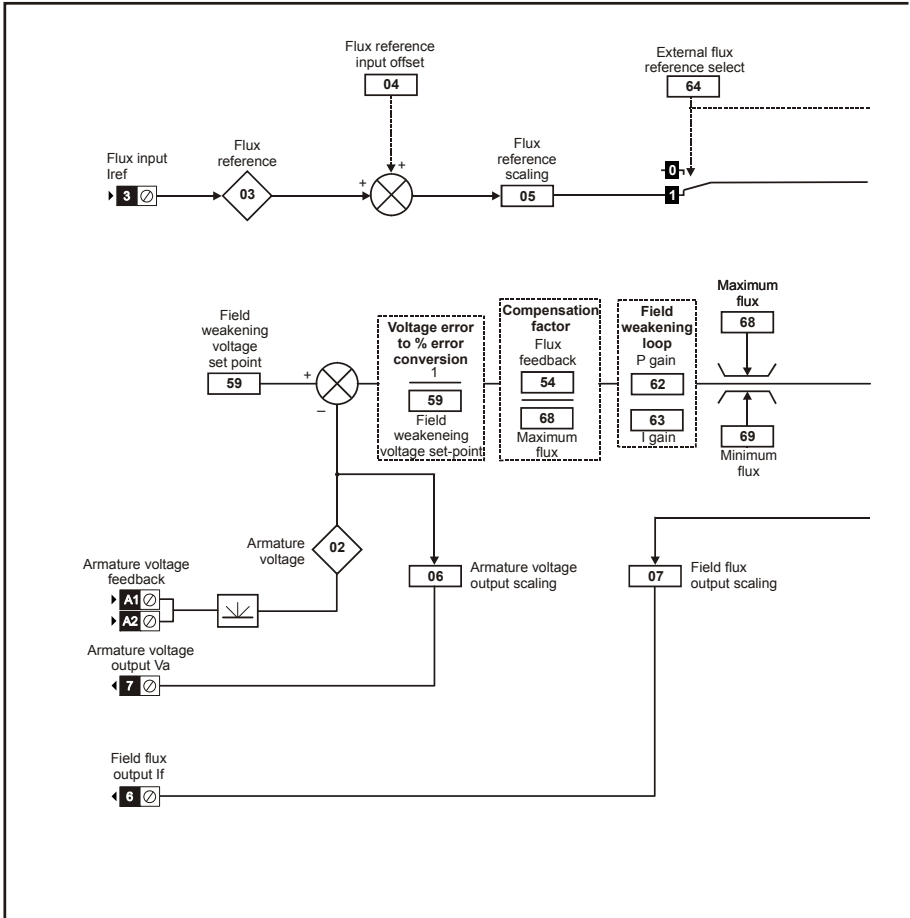

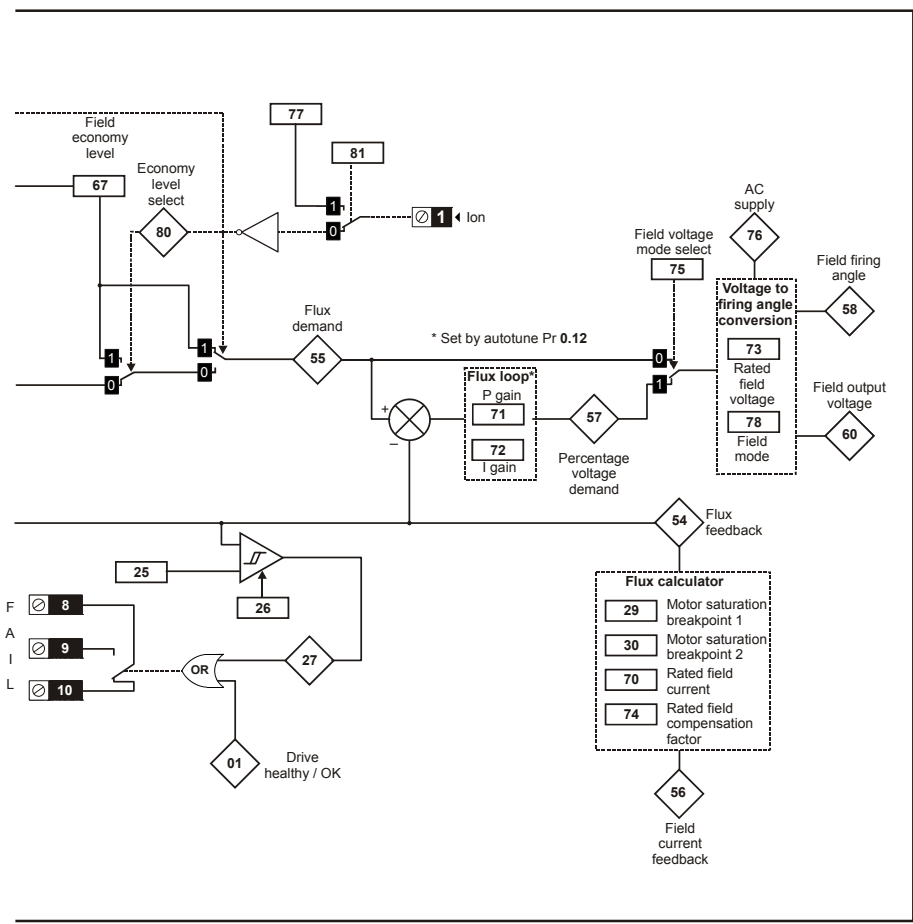

Table 7-2 Quick start commissioning / start up from defaults for Mentor MP mode



Action	Detail	
Before power up	Ensure: <ul style="list-style-type: none"> • Motor field is connected. • The MP port on the FXMP25 is connected to the external field controller port on the Mentor MP using a shielded straight through RJ45 to RJ45 lead, maximum length 100 m. • Mentor MP software must be V01.05.01 or later. 	
Power up the field controller	Ensure: <ul style="list-style-type: none"> • The field controller displays:  • If the field controller trips, see Chapter 9 Diagnostics on page 60. 	
Select Mentor MP mode	To select MP mode <ul style="list-style-type: none"> • Set Pr 78 (Field mode) = MP (1) • Press the mode button to enter parameter view mode • Press and hold the mode button for at least 2 seconds to carry out a reset. 	
Setting up the field controller	The Mentor MP has taken control of the FXMP25. Setting up should now be carried out using the Mentor MP. Please refer to the running a motor section in Mentor MP Short Form Guide.	
Setting in MP	Set Pr 5.78 to EXTERNAL	

Table 7-3 Quick start commissioning / start up from defaults for Mentor II mode



Action	Detail	
Before power up	Ensure: <ul style="list-style-type: none"> • Motor field is connected. • The Mentor II port on the FXMP25 is connected to the Mentor II using a 10 way IDC to IDC ribbon. • The supply phases FXMP25 (L1 to L3) are in the same phase as on the Mentor II (E1 to E3). 	
Power up the field controller	Ensure: <ul style="list-style-type: none"> • The field controller displays:  • If the field controller trips, see Chapter 9 Diagnostics on page 60. 	
Setting up the field current feedback scaling	<ul style="list-style-type: none"> • Set parameter Pr 11 on FXMP25 to be the same value as Pr 6.11 on Mentor II. 	
Select Mentor II mode	To select Mentor II mode <ul style="list-style-type: none"> • Set Pr 78 (Field mode) = 2.H (2) for Mentor II mode, half control (ensure Pr 6.22 on Mentor II is set accordingly). • Set Pr 78 (Field mode) = 2.F (3) for Mentor II mode, full control (ensure Pr 6.22 on Mentor II is set accordingly). • Press the mode button to enter parameter view mode. • Press and hold the mode button for at least 2 seconds to carry out a reset. 	
Setting up the field controller	The Mentor II has taken control of the FXMP25. Setting up should now be carried out using the Mentor II. Please refer to the Mentor II User Guide Menu 6.	
To setup flux OK relay	Set Pr 25 and Pr 26 to the value required. Default values are set to switch at 10 % current, the same as FXM5.	

Figure 7-3 Mentor II mode



Refer to Mentor II *User Guide* Issue 14 page 95 for Mentor II block diagram.

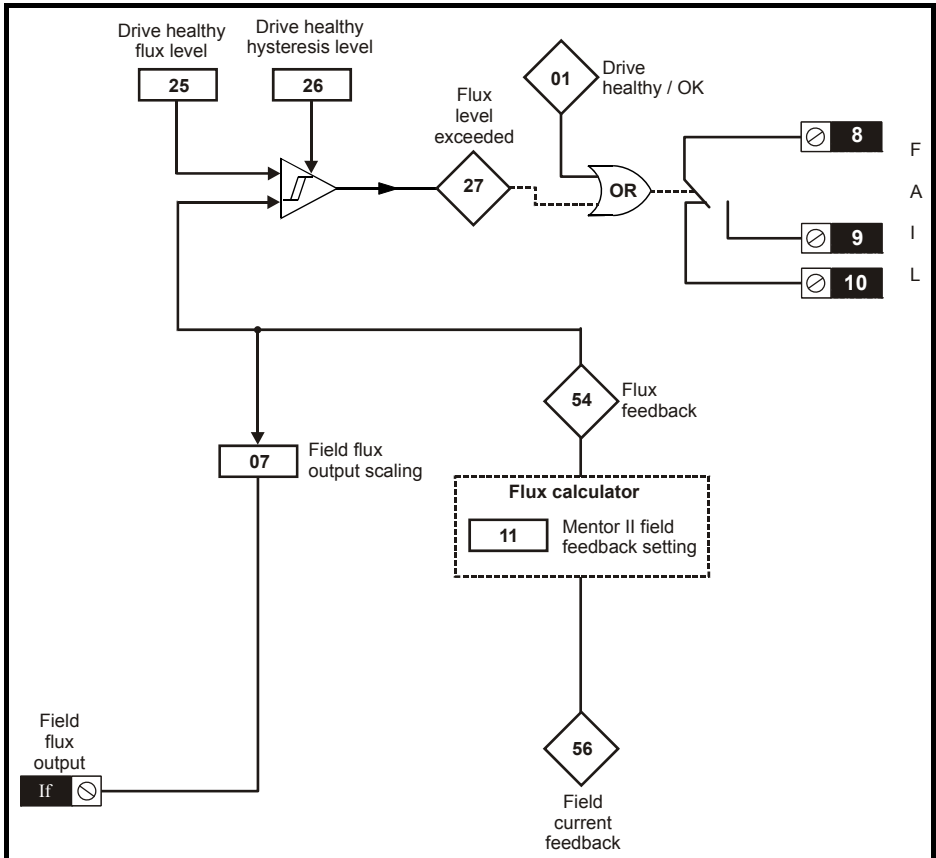

WARNING

Thermal overload in Mentor II mode works by forcing current feedback to zero causing the relay to operate. When Mentor II is enabled, this causes the drive to trip FdL (field loss). When in the disabled state, FdL trip is not active on Mentor II, and therefore following loss of feedback Mentor II will advance the firing angle to the end stop which will cause the output of the FXMP to reach maximum voltage set by the front end stop Pr 6.21.

When using FXMP 25 with Mentor II, Pr 6.21 must be set in order to avoid field over voltage conditions during fault conditions. (Refer to Pr 6.21 on page 64 in the *Mentor II User Guide* for an example calculation). FXMP relay and Mentor II logic functions should be used to set Pr 6.13 to 0 to disable firing pulses during fault conditions in the disabled state.



FXMP25 Thermal Protection in Mentor 2 Mode.

The following parameter setting can be used to provide indication to the Mentor 2 if overtemperature condition is reached.

Pr **9.23** = 1012 - digital output ST5 set to 'drive OK / healthy'.

Pr **8.18** = 613 - digital input to control Pr **6.13** (field enable).

Pr **12.03** = 604 - use programmable threshold to detect when firing angle reaches front end-stop.

Pr **12.04** = 1000.

Pr **9.13** = 806

Pr **9.15** = 1201 - digital output 1 indicates when firing angle end-stop is reached.

Pr **9.07** = 806

Pr **9.09** = 8.11 – drive disabled.

Pr **8.17** = 1034 – force an 'Et' trip if FXMP25 relay opens and firing angle reaches end-stop and drive is disabled.

Connect digital outputs 1 and 2 and digital input 7 together.

Connect normally open contacts of FXMP25 relay to digital input 6.

8 Technical data

8.1 Ratings

The continuous output current rating given is for a maximum ambient temperature of 40 °C (104 °F) and an altitude of 1000 m. For operation at higher temperatures and altitudes derating is required.

Maximum continuous input current

The value of the maximum continuous input current is given to aid the selection of cables and fuses. The value is stated for worst-case conditions.

Continuous AC input current A	Continuous DC output current A
26	25

8.2 FXMP25 derating for extended ambient operation

Figure 8-1 FXMP25 derating for extended ambient operation

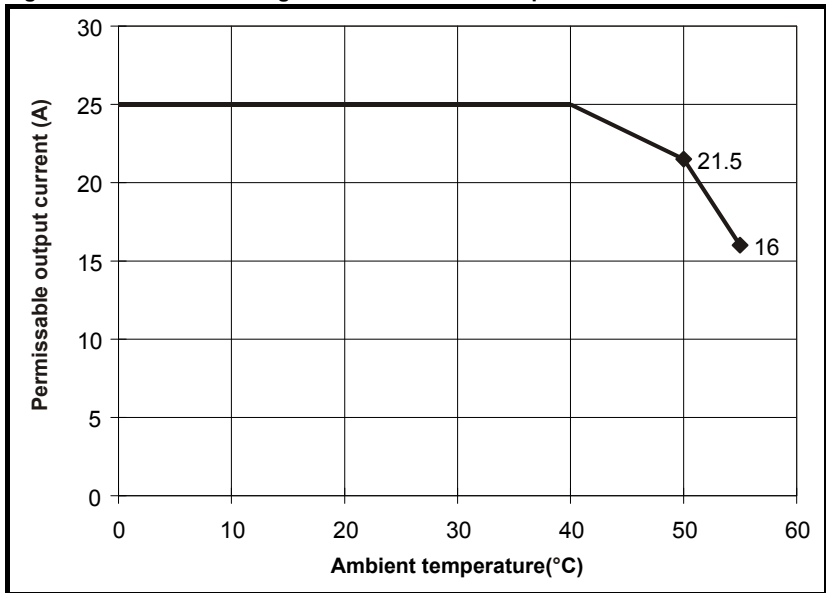

8.3 Power dissipation

Table 8-1 shows the maximum field controller losses, assuming 480 V supply on a 300 V field.

Table 8-1 Field controller losses

Loss @ 40 °C W	Loss @ 50 °C W	Loss @ 55 °C W
85.5	81.6	73.6

8.4 AC supply requirements

The FXMP25 is rated for a nominal supply up to 480 Vrms.

8.4.1 Supply types

The FXMP25 is suitable for use with any supply type, i.e. TN-S, TN-C-S, TT, IT, with grounding at any potential, i.e. neutral, centre or corner (grounded-delta).

8.4.2 AC supply specification

Table 8-2 AC supply

Specification	Product voltage variant
Maximum nominal supply	480 V
Tolerance	10 %
Minimum nominal supply	208 V
Tolerance	-10 %

8.5 Line reactors

The FXMP25, in common with all naturally commutated SCR drives, causes voltage notches at the input supply terminals. To avoid disturbances with other equipment using the same supply, the addition of external line inductance is strongly recommended in order to restrict the depth of notches imposed. This is generally not necessary where a dedicated transformer is used to supply the FXMP25.

The following recommendations for added line inductance, have been calculated based on the power drive systems standard: EN 61800-3:2004 "Adjustable speed electrical power drive systems - Part 3: EMC requirements and specific test methods".

Table 8-3 Minimum values of L_{add} and inductor current rating for a typical application

Field output current	System voltage		Typical current rating
	400 V	480 V	
A	μH	μH	A
25	230	290	26

NOTE

On typical field windings or high inductance loads the output current is smooth DC and therefore the rms input current is approximately equal to the DC output current. The above assumes the supply has 1.5 % impedance and a minimum supply rating of 5 kA.



Control of currents below 250 mA (thyristor holding currents) should be avoided. If control at this level is required then line reactors must be installed to reduce the effect of dv/dt as thyristors turn off.

8.6 Temperature and humidity

Ambient temperature operating range:

0 °C to 55 °C (32 °F to 131 °F)

Field output current derating must be applied at temperature >40 °C (104 °F).

Minimum temperature at power-up:

The FXMP25 will power up at -15 °C (5 °F).

Maximum humidity:

The FXMP25 can operate in environments up to a maximum relative humidity: 90 % non-condensing at 50 °C.

8.7 Storage

Storage temperature range: -40 to 70 °C.

Storage time is 2 years.

Electrolytic capacitors in any electronic product have a storage period after which they require reforming or replacing.

The DC bus capacitors have a storage period of 10 years.

The low voltage capacitors on the control supplies typically have a storage period of 2 years and are thus the limiting factor.

Low voltage capacitors cannot be reformed due to their location in the circuit and thus may require replacing if the FXMP25 is stored for a period of 2 years or greater without power being applied.

It is therefore recommended that the FXMP25 is powered up for a minimum of 1 hour after every 2 years of storage.

This process allows the FXMP25 to be stored for a further 2 years.

8.8 Altitude

Altitude range: 0 to 3,000 m (9,900 ft), subject to the following conditions:

1,000 m to 3,000 m (3,300 ft to 9,900 ft) above sea level: de-rate the maximum output current from the specified figure by 1 % per 100m (330 ft) above 1,000 m (3,300 ft)

For example at 3,000 m (9,900 ft) the output current of the drive would have to be de-rated by 20 %.

8.9 IP rating

The FXMP25 is rated to IP20 pollution degree 2 (dry, non-conductive contamination only).

The IP rating of a product is a measure of protection against ingress and contact to foreign bodies and water. It is stated as IP XX, where the two digits (XX) indicate the degree of protection provided as shown in Table 8-4.

Table 8-4 IP rating degrees of protection

First digit		Second digit	
Protection against contact and ingress of foreign bodies		Protection against ingress of water	
0	No protection	0	No protection
Protection against large foreign bodies $\phi > 50$ mm (large area contact with the hand)		1	Protection against vertically falling drops of water
2	Protection against medium size foreign bodies $\phi > 12$ mm (finger)	2	Protection against spraywater (up to 15 ° from the vertical)
3	Protection against small foreign bodies $\phi > 2.5$ mm (tools, wires)	3	Protection against spraywater (up to 60 ° from the vertical)
4	Protection against granular foreign bodies $\phi > 1$ mm (tools, wires)	4	Protection against splashwater (from all directions)
5	Protection against dust deposit, complete protection against accidental contact.	5	Protection against heavy splash water (from all directions, at high pressure)
6	Protection against dust ingress, complete protection against accidental contact.	6	Protection against deckwater (e.g. in heavy seas)
7	-	7	Protection against immersion
8	-	8	Protection against submersion

8.10 Corrosive gasses

Concentrations of corrosive gasses must not exceed the levels given in:

- Table A2 of EN 50178:1998
- Class 3C2 of IEC 60721-3-3

This corresponds to the levels typical of urban areas with industrial activities and/or heavy traffic, but not in the immediate neighborhood of industrial sources with chemical emissions.

8.11 RoHS compliance

FXMP25 meets EU directive 2002-95-EC for RoHS compliance.

8.12 Vibration

Maximum recommended continuous vibration level 0.14 g rms broad-band 5 to 200 Hz.

NOTE

This is the limit for broad-band (random) vibration. Narrow-band vibration at this level which coincides with a structural resonance could result in premature failure.

Bump test

Testing in each of three mutually perpendicular axes in turn.
Referenced standard: IEC 60068-2-29: Test Eb:
Severity: 18 g, 6 ms, half sine
No. of Bumps: 600 (100 in each direction of each axis)

Random vibration test

Testing in each of three mutually perpendicular axes in turn.
Referenced standard: IEC 60068-2-64: Test Fh:
Severity: $1.0 \text{ m}^2/\text{s}^3$ ($0.01 \text{ g}^2/\text{Hz}$) ASD from 5 to 20 Hz
-3 dB/octave from 20 to 200 Hz
Duration: 30 minutes in each of 3 mutually perpendicular axes.

Sinusoidal vibration test

Testing in each of three mutually perpendicular axes in turn.
Referenced standard: IEC 60068-2-6: Test Fc:
Frequency range: 5 to 500 Hz
Severity: 3.5 mm peak displacement from 5 to 9 Hz
10 m/s^2 peak acceleration from 9 to 200 Hz
15 m/s^2 peak acceleration from 200 to 500 Hz
Sweep rate: 1 octave/minute
Duration: 15 minutes in each of 3 mutually perpendicular axes.

EN 61800-5-1:2007, Section 5.2.6.4. referring to IEC 60068-2-6
Frequency range: 10-150 Hz
Amplitude: 10-57 Hz @ 0.075 mm pk
57-150 Hz @ 1g pk
Sweep rate: 1 octave/minute
Duration: 10 sweep cycles per axes in each of 3 mutually perpendicular axes

8.13 Acoustic noise

The internal fan generates the majority of the acoustic noise produced by the field controller.

FXMP25 sound pressure level at 1 m = 44.5 dBA.

8.14 Overall dimensions

Refer to Figure 3-3 *Overall dimensions* on page 13.

8.15 Weight

The overall weight of the FXMP25 is 1.70 kg (3.70 lb).

8.16 Cable and fuse size ratings

Refer to section 4.5 *Cable and fuse size ratings* on page 18.

Safety information

Product information

Mechanical installation

Electrical installation

Getting started

Parameters

Setting-up

Technical data

Diagnostics

UL listing information

8.17 Electromagnetic compatibility (EMC)

This is a summary of the EMC performance of the FXMP25. For full details, refer to the FXMP25 EMC data sheet which can be obtained from the supplier of the FXMP25.

Table 8-5 Immunity compliance

Standard	Type of immunity	Test specification	Application	Level
EN 61000-4-2 IEC 61000-4-2	Electrostatic discharge	6 kV contact discharge 8 kV air discharge	Module enclosure	Level 3 (industrial)
EN 61000-4-3 IEC 61000-4-3	Radio frequency radiated field	80 % AM (1 kHz) modulation Levels prior to modulation: 10V/m 80 - 1000 MHz 3V/m 1.4 – 2.0 GHz 1V/m 2.0 – 2.7 GHz	Module enclosure	Level 3 (industrial)
EN 61000-4-4 IEC 61000-4-4	Fast transient burst	5/50ns 2 kV transient at 5 kHz repetition frequency via coupling clamp	Control lines	Level 4 (industrial harsh)
		5/50ns 2 kV transient at 5 kHz repetition frequency by direct injection	Power lines	Level 3 (industrial)
EN 61000-4-5 IEC 61000-4-5	Surges	Common mode 4 kV 1.2/50 μ s waveshape	AC supply lines: line to ground	Level 4
		Differential mode 2 kV	AC supply lines: line to line	Level 3
		Common mode 1 kV	Control lines ¹	
EN 61000-4-6 IEC 61000-4-6	Conducted radio frequency	10 V prior to modulation 0.15 - 80 MHz 80 % AM (1 kHz) modulation	Control and power lines	Level 3 (industrial)
EN 61000-4-11 IEC 61000-4-11	Voltage dips, short interruptions & variations	All durations	AC supply lines	
EN 61000-4-8 IEC 61000-4-8	Power frequency magnetic field	Exceeds level 5	Module enclosure	Level X (1mT)
EN 61000-6-1:2007 IEC 61000-6-1	Generic immunity standard for the residential, commercial and light - industrial environment			Complies
EN 61000-6-2:2005 IEC 61000-6-2	Generic immunity standard for the industrial environment			Complies
EN 61800-3:2004 IEC 61800-3	Product standard for adjustable speed power drive systems (immunity requirements)		Meets immunity requirements for first and second environments	

¹ See section 4.6.1 *Surge immunity of control circuits - long cables and connections outside a building* on page 22 for control ports for possible requirements regarding grounding and external surge protection.

Emission

The following standards are met for cable lengths up to 100m.

Table 8-6 FXMP25 emission compliance

Filter	Conformity
No filter	C4
Schaffner FN3280H-25-33	C2

Filters can be sourced directly from Schaffner.

Key (shown in decreasing order of permitted emission level):

- C4 EN 61800-3:2004 second environment, restricted distribution (Additional measures may be required to prevent interference).
- C2 Industrial generic standard EN 61000-6-4:2007.
EN 61800-3:2004 first environment restricted distribution (The following caution is required by EN 61800-3:2004).



This is a product of the restricted distribution class according to IEC 61800-3. In a residential environment this product may cause radio interference in which case the user may be required to take adequate measures.

EN 61800-3:2004 defines the following:

- The first environment is one that includes residential premises. It also includes establishments directly connected without intermediate transformers to a low-voltage power supply network which supplies buildings used for residential purposes.
- The second environment is one that includes all establishments other than those directly connected to a low-voltage power supply network which supplies buildings used for residential purposes.
- Restricted distribution is defined as a mode of sales distribution in which the manufacturer restricts the supply of equipment to suppliers, customers or users who separately or jointly have technical competence in the EMC requirements of the application of drives.

9 Diagnostics

The display on the FXMP25 gives various information about the status of the field controller. These fall into three categories:

- Trip indications
- Alarm indications
- Status indications



Users must not attempt to repair a faulty FXMP25 or carry out fault diagnosis other than replace internal fuses or through the use of the diagnostic features described in this chapter. Under no circumstances must the casing of the FXMP25 be opened when the AC supply is connected. Faulty units must be returned to an authorized Control Techniques distributor for repair.

9.1 Trip indications

If the unit trips, the field output is disabled and the FXMP25 ceases to control the field. The left hand display indicates that a trip has occurred, and the right hand display shows the trip.

Trips are listed alphabetically in Table 9-1 based on the trip indication shown on the FXMP25 display.

Example

The FXMP25 display shows an FdL trip on the display as shown in Figure 9-1 below:

Figure 9-1 Typical example of trip display

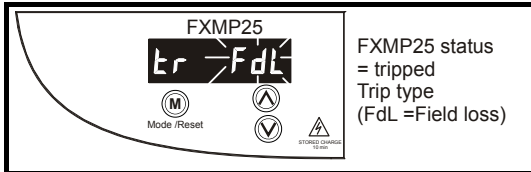

The above graphic shows the resultant display following an FdL trip. This indicates a field loss condition as described in Table 9-1 on page 61 overleaf.

Table 9-1 Trip indications

Trip	Diagnosis
EEF	Internal EEPROM trip
	Internal FXMP25 EEPROM checksum. When this trip occurs all the parameters are set to default. The trip can only be removed by entering a load default command (i.e. Eur or USA) into Pr 00 before re-setting the FXMP25.
FdL	No current in the field supply circuit
	Check the field circuit. Check the FXMP25 internal fuses.
FOC	Excess current detected field current feedback
	Maximum field current is present. Check the field rated current (Pr 70) and the field rated voltage (Pr 73) are set correct to the motor nameplate. Check for short circuit on field circuit cabling. Check integrity of motor insulation.
HF06	Unexpected interrupt
	Hardware fault - return to supplier
HF07	Watchdog failure
	Hardware fault - return to supplier
HF08	Interrupt clash
	Hardware fault - return to supplier
HF11	Access to the EEPROM failed
	Hardware fault - return to supplier
HF17	No comms from power processor
	Hardware fault - return to supplier
HF19	Flash failure
	Hardware fault - return to supplier
HF21	Power processor - Watchdog failure
	Hardware fault - return to supplier
HF22	Power processor - Unexpected interrupt
	Hardware fault - return to supplier
HF23	Power processor - Level overrun
	Hardware fault - return to supplier
HF24	Power processor - No frequency at power up
	Hardware fault - return to supplier
HF29	Fan fault
	Hardware fault - return to supplier
O.ht1	FXMP25 overheat (SCR junction) based on thermal model
	<ul style="list-style-type: none"> Reduce ambient temperature or field current Check the fans are operating and venting is not blocked
O.ht2	Heatsink over temperature
	<ul style="list-style-type: none"> Reduce ambient temperature or field current Check the fans are operating and venting is not blocked

Safety information

Product information

Mechanical installation

Electrical installation

Getting started

Parameters

Setting-up

Technical data

Diagnosics

UL listing information

Trip	Diagnosis
OV	Over voltage
	<ul style="list-style-type: none"> Check AC supply is within specification Check that notching on the AC supply is not excessive. Refer to section 8.5 <i>Line reactors</i> on page 54
PS	Internal FXMP25 power supply trip
	Return to the supplier
PS.24	24V comms power supply overload
	Check connection to the Mentor MP / serial port connector
Tune	Autotune stopped before completion
	See Pr 12 (Autotune)

9.2 Trip categories

Trips can be grouped into the following categories. It should be noted that a trip can only occur when the FXMP25 is not tripped or is already tripped but with a trip with a lower priority number.

Table 9-2 Trip categories

Priority	Category	Trips	Comments
1	Hardware faults	HF01 to HF11	These indicate fatal problems and cannot be reset. The FXMP25 is inactive after one of these trips and the display shows HFxx.
2	Self resetting trips	UV	Under voltage trip cannot be reset by the user, but is automatically reset by the FXMP25 when the supply voltage is within specification.
3	Non-resetable trips	HF17 to HF29	Cannot be reset
4	EEF trip	EEF	Cannot be reset unless a code to load defaults is first entered in Pr 00
5	Normal trips	All other trips not included in this table	Can be reset after 1.0s

Unless otherwise stated, trips cannot be reset until 1.0s after the trip has been triggered by the FXMP25

9.3 Alarm indications

Table 9-3 Alarm indications

Right hand display	Description
hot	Heatsink temperature too high
	The heatsink temperature is approaching the over temperature threshold (see O.ht2).
FAIL	Load default when the FXMP25 is active
	An attempt has been made to default the FXMP25 when it is enabled [Pr 77 = On (1)].
n.SEr	No communication between FXMP25 and Mentor MP
	The FXMP25 cannot communicate with the Mentor MP

9.4 Status indications

Table 9-4 Status indications

Left hand display	Description
ih	Field controller inhibited
The field controller is inhibited because the field controller is disabled [Pr 77 = OFF (0)].	
tr	Field controller has tripped
The field controller has tripped. The trip code will be displayed in the 'right hand' display (see Chapter 9 <i>Diagnostics</i> on page 60).	
rn	Field controller is running
The field controller is in a run state. Pr 78 = Mode Selected and Pr 77 = On (1) in Standalone Mode or Mentor MP Pr 5.77 = On (1) In MP Mode or Mentor II ribbon cable is connected in Mentor II mode.	

9.5 Displaying the trip history

The FXMP25 retains the last four trips that have occurred. Table 9-5 shows parameters used to store the last four trip.

Table 9-5 Trips

Parameter	Description
90	Trip 0 (most recent trip)
91	Trip 1
92	Trip 2
93	Trip 3

9.6 Behavior of the FXMP25 when tripped

If the FXMP25 trips the output of the FXMP25 is disabled so that the FXMP25 stops controlling the field. If any trip occurs the following read only parameters are frozen to help in diagnosing the cause of the trip.

Table 9-6 Parameters frozen on trip

Parameter	Description
02	Armature voltage
54	Flux feedback
56	Field current feedback
58	Field firing angle
03	Flux reference

Analog and digital I/O

The analog and digital I/O on the FXMP25 continue to work correctly if a trip occurs.

10 UL listing information

FXMP field controller has been assessed to comply with both URus and cUR requirements.

Control Techniques UL file number is E171230. Confirmation of UL recognition can be found at website: www.ul.com.

10.1 Conditions of acceptability

Conformity: The field controller conforms to UL recognition requirements only when the following are observed.

1. The Device shall be installed in a pollution degree 2.
2. The terminal torques specified in section 3.2 *Electrical terminals* on page 14 are to be used.
3. Field wiring is to be class 1, 75 °C copper wire only
4. The field controller is to be installed in an enclosure having adequate strength and thickness to the intended manner and with acceptable spacings provided.
5. This unit has been tested together with the Mentor MP range of DC drives for field loss detection. When other DC drives are used, loss of field current or voltage detection shall be provided, this detection shall prevent motor over speed upon field loss.
6. FS1 and FS2 shall be fuse type FR10GR69V30 by Ferraz Shawmut (E76491), rated 30 A, 690 Vac.
7. Suitable for use on a circuit capable of delivering not more than 100 kA RMS symmetrical Amperes, 480 Vac maximum. When protected by a class CC fuse with an IAC rating of 100 kA minimum and rated at 30 A maximum.
8. The surrounding air temperature of the device does not exceed 40 °C when the device is operating.
9. BCP fusing is to be provided in accordance with NEC requirements.

10.2 AC supply specification

The maximum UL supply voltage is 480 Vac.

The device is suitable for use in a circuit capable of delivering not more than 100,000 rms symmetrical amperes at 480 Vac when installed as per point 7 above in section 10.1.

10.3 Maximum continuous current

The device is listed as having the maximum continuous current ratings as specified in section 2.1 *Ratings* on page 9.



SCIGATE AUTOMATION (S) PTE LTD

No.1 Bukit Batok Street 22 #01-01 Singapore 659592

Tel: (65) 6561 0488

Fax: (65) 6562 0588

Email: sales@scigate.com.sg

Web: www.scigate.com.sg

Business Hours: Monday - Friday 8.30am - 6.15pm



0476-0009-03